

Load reduction and arching on buried rigid culverts using EPS Geofam. Design method and instrumented field tests.

Jan Vaslestad, NPRA, jan.vaslestad@vegvesen.no

Murad S. Sayd, NPRA, murad.sayd@vegvesen.no

Tor H. Johansen, NPRA, tor-helge.johansen@vegvesen.no

Louise Wiman, NPRA, louwim@vegvesen.no

NPRA - Norwegian Public Roads Administration

Abstract:

The earth pressure on deeply buried culverts is significantly affected by arching. Both the magnitude and distribution of earth pressure on buried culverts are known to depend on the relative stiffness of the culvert and the soil. The so-called induced trench method (also called imperfect ditch) involves installing a compressible layer above the rigid culvert. As the embankment is constructed, the soft zone compresses more than the surrounding fill, and thus induces positive arching above the culvert.

Four instrumented field tests using EPS Geofam for load reduction on buried rigid culverts are performed in Norway. The culverts were built and instrumented in the period from 1988 to 1992. The method involves installing a compressible inclusion (EPS Geofam) above rigid culverts in order to reduce the vertical earth pressure. Three of the field tests are concrete pipes with granular backfill, and one field test is a cast in place concrete box culvert with silty-clay backfill.

The long-term observations of earth pressure and deformation are presented, and compared with a simplified design method.

INTRODUCTION

The problem of earth pressure on buried structures has a great practical importance in constructing embankments over pipes and culverts. The earth pressure on deeply buried culverts is significantly affected by arching. Both the magnitude and distribution of earth pressure on buried culverts are known to depend on the relative stiffness of the culvert and the soil. The vertical earth pressure on a rigid culvert is greater than the calculated overburden pressure above the structure which, result in a negative arching effect.

The so-called induced trench method (also called imperfect ditch) involves installing a compressible layer above the rigid culvert. As the embankment is constructed, the soft zone compresses more than the surrounding fill, and thus induces positive arching above the culvert.

Expanded Polystyrene (EPS) geofam blocks have been used for load reduction on buried rigid pipes under high fill since 1988 in Norway. The deformation in the EPS geofam provides a mobilization of shear strength in the fill and reduces the expected vertical earth pressure. The properties of soil-structure interaction in the buried culverts highly depend on the mechanical properties of the backfill material and the stiffness of the compressible material, the expanded polystyrene (EPS) geofam in this case. A better understanding of the arching effect of EPS on buried culverts has been obtained from a field-based study using full-scale test measurements. Terzaghi (1943) stated that the amount of arching can only be obtained by direct measurement under field conditions. The instrumented field installations presented in this paper were built in

Norway in the period between 1988 and 1992. Four Long-term measurements (three concrete pipes with granular fill and one cast in place box culvert with silty clay back fill) of deformation and earth pressure on buried concrete pipes were carried out using hydraulic pressure cells.

In the later years, this method using geofoam to reduce earth pressure have also been used on concrete culverts below high fills in China, Yang et al. (2005), Zhang et al. (2006) and McAfee et al. (2008).

FIELD INSTALLATIONS

Four long-term measurements of deformation and earth pressure on buried concrete pipes were carried out using hydraulic pressure cells. The field installations were carried out during the period 1988 to 1992. To measure the vertical and horizontal earth pressures around the concrete pipe, hydraulic earth pressure measuring cells has been installed as shown in the figures below. Geometrical arrangements and registered results are presented below for each case. Standard expanded polystyrene (EPS) blocks 0.5 x 1.0 x 2.0 m were used as a compressible layer to create positive arching. The compressive strength of the EPS was 100 kPa and density 20 kg/m³. The effect of the width of the compressible layer is insignificant with respect to vertical overburden pressure on the pipe and therefore, not discussed in this paper. Only the measured vertical earth pressure and deformations are presented. The registered horizontal pressure at the springline of the pipe is not included in this paper. More detailed result from instrumented field tests are shown in Vaslestad et al. (2008).

1. Field installation- Eidanger, (1988)

The first field installation built in 1988 is a concrete pipe with outer diameter 1.95 m beneath a 14 m high rock-fill embankment. The geometry of the instrumented cross section with the extent of backfill zone is shown in figure 1 below.

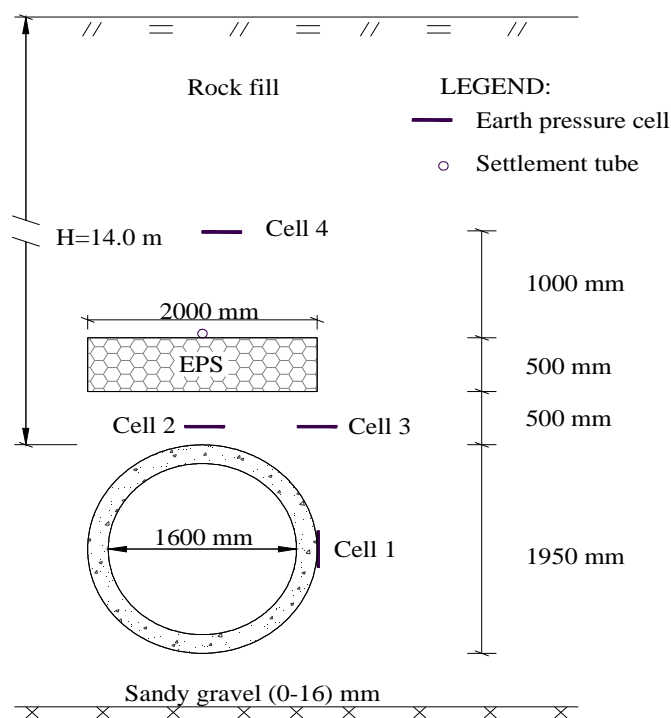

Figure 1 Locations of pressure cells and EPS geofoam above the pipe

The pipe was placed after the in situ soil was excavated to about 0.5 m below the culvert elevation, down to bedrock, and replaced by 0-16 mm sandy gravel. The same material (0-16

mm sandy gravel) was used for backfill, with a compaction requirement of 97 % Standard Proctor. The backfill extended 1 m out from the springline and 0.5 m over the top of the pipe. The remaining fill in the embankment was rock-fill that was placed in 3 m thick layers, and compacted to 95-97 % Standard Proctor. The construction began in August 1988 and was completed in June 1989.

Results from the registered vertical pressures on cell 2, are shown in the figure 2 below. The earth pressure on cell 2 increased to 72 kPa in September 1988 when the fill height was 8.3 m. Further increase of fill height to 13.7 m did not increase the earth pressure. In the period between January 1996 and January 2008, the earth pressure on the top of the pipe was registered as relatively constant around 66 - 68 kPa, which is 25 % of the calculated overburden pressure.

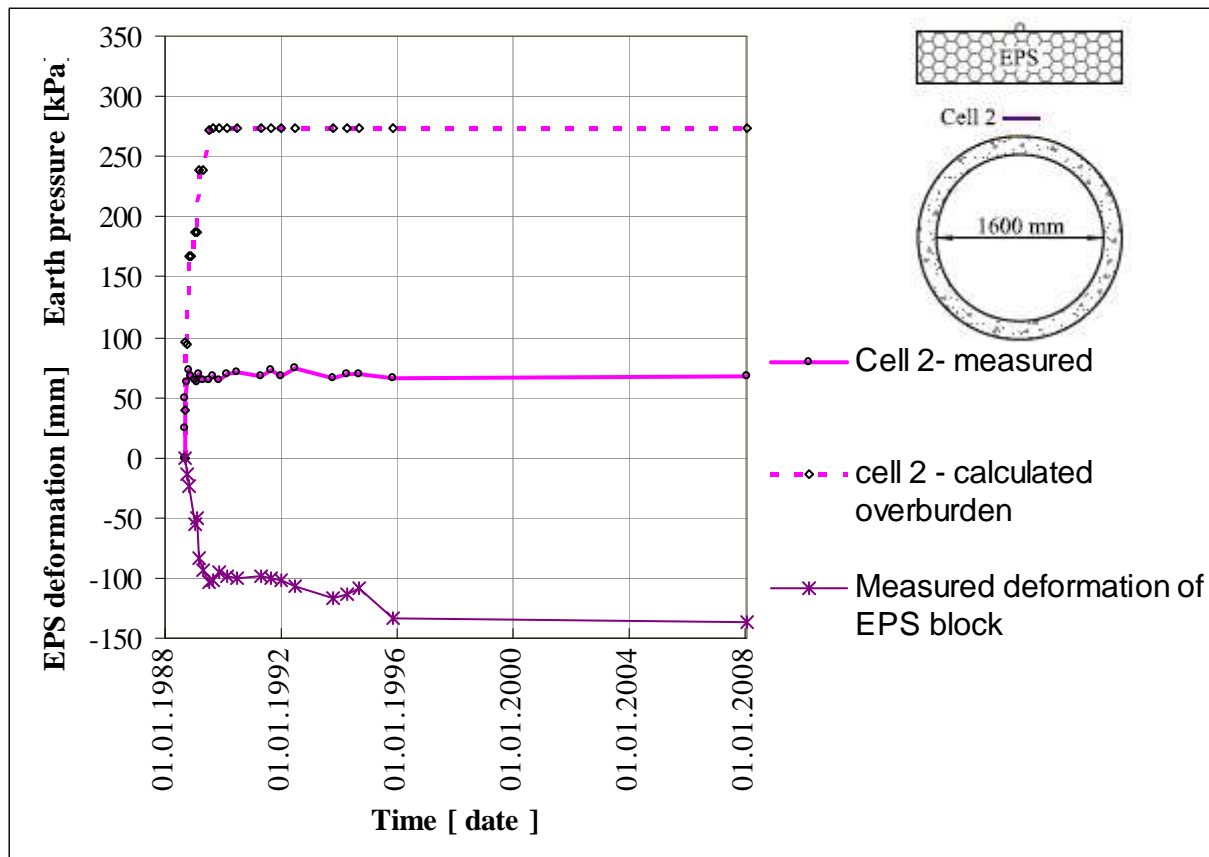

Figure 2 Vertical overburden pressures and deformation of EPS geofoam block

The registered vertical compression of the EPS geofoam is also shown in figure 2 above. The vertical deformation stabilises around 140 mm. The result showed no further increase after almost 12 years of measurements. The measured deformation is 28 % of the initial thickness of the EPS block.

2. Field installation- Sveio, 1989

The second field installation was a concrete pipe culvert with inner diameter 1.4 m and outer diameter 1.71 m. The embankment above the culvert was a 15 m rock-fill. The in-situ soil consisted of dense moraine. Well graded sandy gravel in a thickness of 400 mm was used as the bedding and backfill. The backfill was compacted in 20 cm thick layers and nuclear field density tests showed an average of 98.5 % Standard Proctor compaction. The backfill extended 1 m out from the springline and 0.5 m above the EPS. The remaining fill in the embankment was rock fill. The average unit weight of soil is $\gamma = 20 \text{ kN/m}^3$. The construction began in November 1989 and in February 1990 the embankment had reached 13.7 m above the pipe. The remaining fill

was placed in the beginning of 1992. The pipe and the backfill were instrumented with 5 hydraulic earth pressure cells of the *Gloetzl* type. Two settlement tubes were also installed on top of the EPS to measure the vertical deformation. The instrumentation is shown in Figure 3.

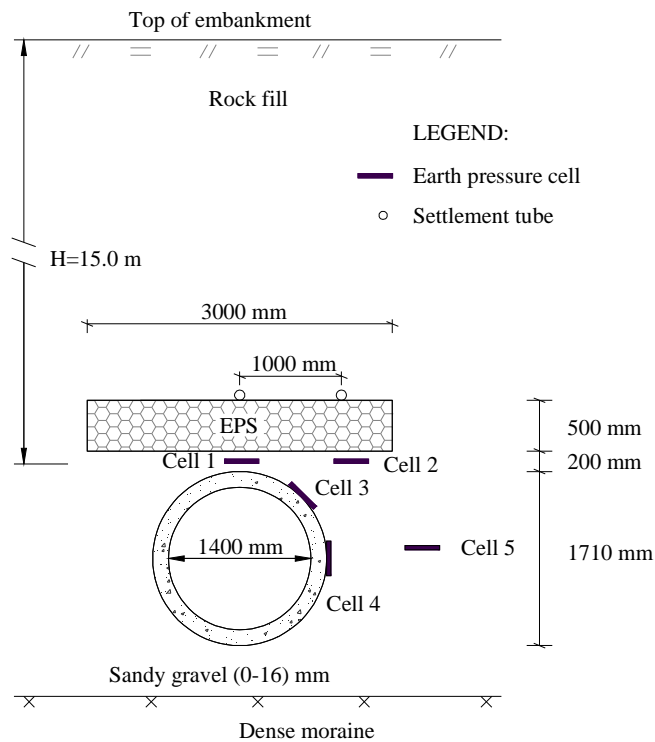

Figure 3 Locations of pressure cells and EPS geofilm above the pipe

The measured earth pressure on cells no. 1 and 2 is shown in figure 4. The registered earth pressure on cell 1 at the top of the pipe is 75 kPa when the fill has reached 15 m above the pipe. In February 2008 the earth pressure was 74 kPa. This is 25 % of the calculated overburden. The earth pressure on cell 2 is slightly larger.

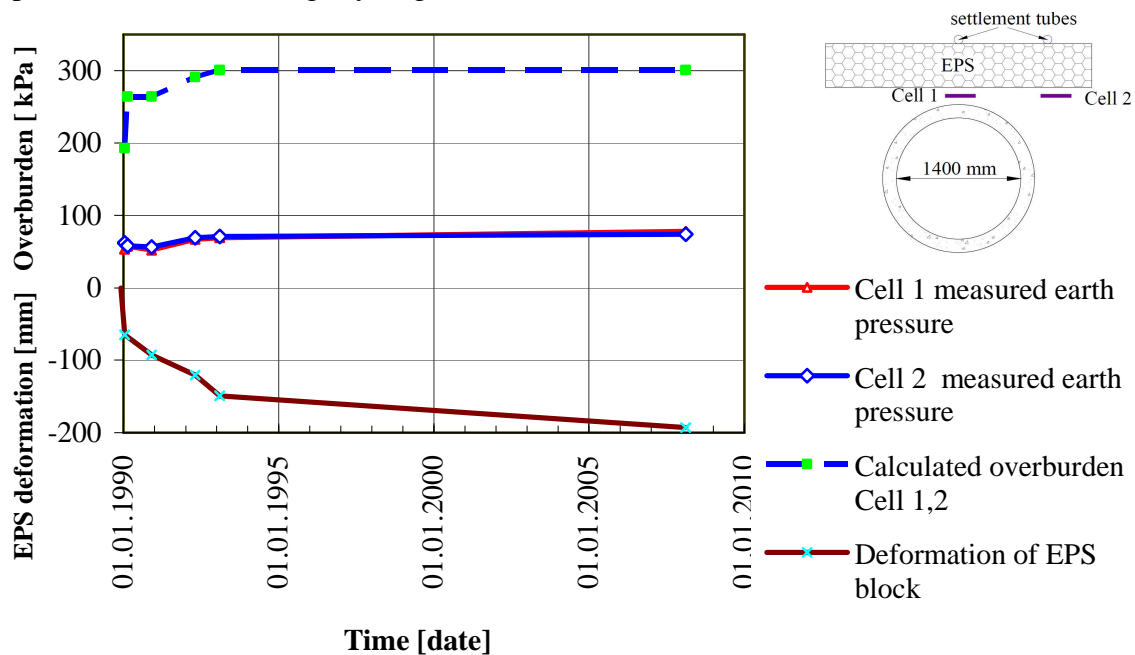

Figure 4 Vertical overburden pressures and deformation of EPS geofilm block

The measured vertical compression of the EPS is also included in figure 4. The deformation is 65 mm at a fill height of 12 m. When the remaining fill up to 15.0 m was placed, the deformation increased to 149 mm. The next measurement, which was taken 15 years later, shows that the deformation increased to 190 mm. This is 38 % of the initial thickness of 50 cm of the EPS geofoam block.

3. Field installation- Hallumsdalen, 1989

A cast-in-place box culvert was also instrumented to monitor the long term performance of the culvert as shown in figure 5. It is a continuous culvert having a total length of 385 m and is crossing a valley beneath an embankment of compacted dry crust clay up to 23 m in height. The subsoil consists of over consolidated silty clay with water content 25-30 % and undrained shear strength 35-70 kPa. To investigate the time effects on the earth pressure in the cohesive fill in the imperfect ditch method, expanded polystyrene was placed above the culvert in a length of 20 m.

The instrumented section of the culvert is situated in the counter fill that is built up with silty clay with unit weight, $\gamma = 20 \text{ kN/m}^3$. The EPS block was placed above the culvert as shown in figure 5. This section (case a, in figure 5) was instrumented with two hydraulic earth pressure cells of the Gloetzl type, cells 1 and 2. The deformation of the EPS was measured using a settlement plate. To compare the earth pressure on the imperfect ditch section with a conventional section, one earth pressure cell was placed above the culvert in a cross-section without EPS, cell 3, see figure 5. The construction of the embankment began in July 1989 and was completed in February 1990

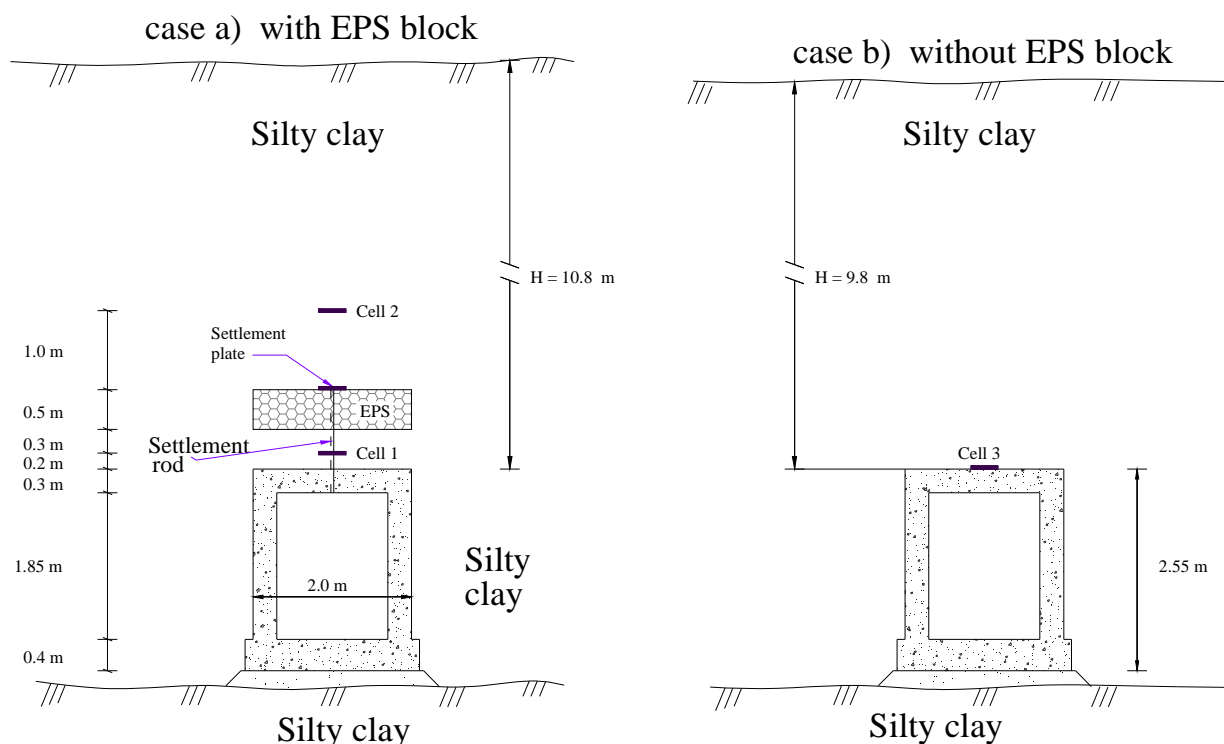

Figure 5 Locations of pressure cells and EPS geofoam above the culvert

At completion of the fill, the fill height was 10.8 m above the cell level with overburden pressure 206 kPa. The measured earth pressure is 132 kPa at this fill height, which is 63 % of the overburden. The earth pressure decreased to 123 kPa in April 1991. The pressure further decreased to 88 kPa in December 1991. This is possibly due to stability problems and movements in the counter fills that occurred in April 1991. The earth pressure stabilised around

100 kPa in 1993. The last measurement carried out in July 2007 showed a value around 92 kPa. This is about 45 % of the calculated overburden pressure. The vertical earth pressure measured with cell 3, which is located on top of the culvert in a section without EPS, is shown in figure 6. At completion of the fill in February 1990, the fill height above the culvert was 9.8 m. Thus the calculated overburden is 196 kPa. The registered earth pressure showed 244 kPa which is 1.24 times the overburden. Based on extensive finite element modelling, Tadros et al. (1989) proposed an expression for calculating the earth pressure on concrete box culverts. For silty clay soil, this expression gives an earth pressure value of 1.17 times the overburden on top of the culvert. The registered earth pressure in July 2007 is 245 kPa.

The measured deformation of the EPS was 60 mm at an overburden of 100 kPa, which corresponds to the compressive strength of the EPS. The deformation was 220 mm at completion of the fill, when the overburden was 196 kPa. For the next four years the deformation gradually increased to 250 mm, which is 50 % of the initial thickness of the EPS. The last measurement carried out in July 2007 shows an increase to 269 mm, this is 54 % of the initial thickness. This shows that the deformation of the EPS in cohesive fill is greater than in granular fills. The observed settlement of the culvert was between 70 and 110 mm in the instrumented sections for the observation period.

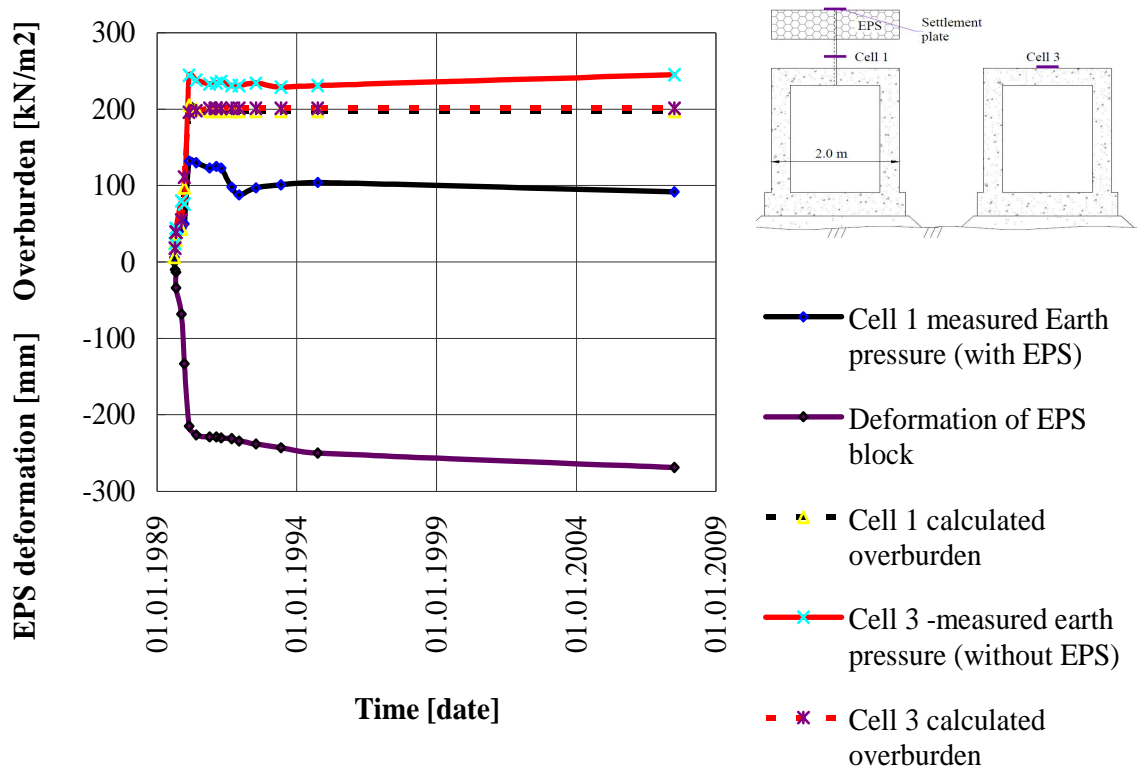

Figure 6 Vertical overburden pressures and deformation of EPS geofoam block

4. Field installation – Tømtebekken, 1991

The last field installation built in 1991 is a concrete pipe culvert with inner diameter 1.4 m and outer diameter 1.73 m. The embankment above the pipe includes 0.5 m EPS geofoam inclusion situated 0.3 m above the crown of the pipe and a total back-fill height of 22 m. The induced trench installation was instrumented to monitor the long-term performance of the EPS geofoam inclusion and the earth pressure history above the culvert for 17 years, figure 7. As shown in figures 8 and 9, the registered vertical earth pressure at the top of the pipe was increased to 80 kPa at fill-height 6 m. Afterwards, only slight increment of the vertical earth pressure is

registered for further increase of fill-height and stabilised around 100 kPa at cell 1 and 150 kPa at cell 2. The earth pressure registered by cell 1 is only 23 % of the overburden pressure at the end of construction. The vertical pressure at the crown of the pipe remained fairly constant afterwards. The filling was started in July 1991 and ended in October 1992.

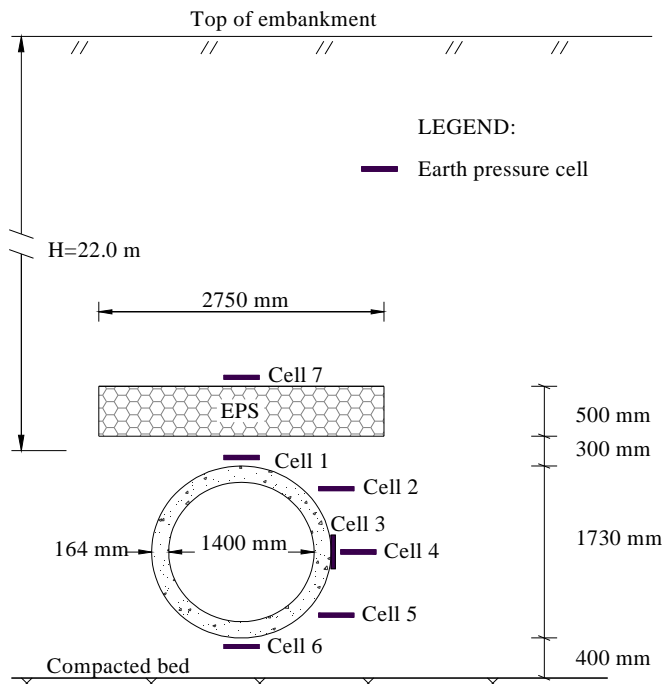

Figure 7 Locations of pressure cells and EPS geofoam above the pipe

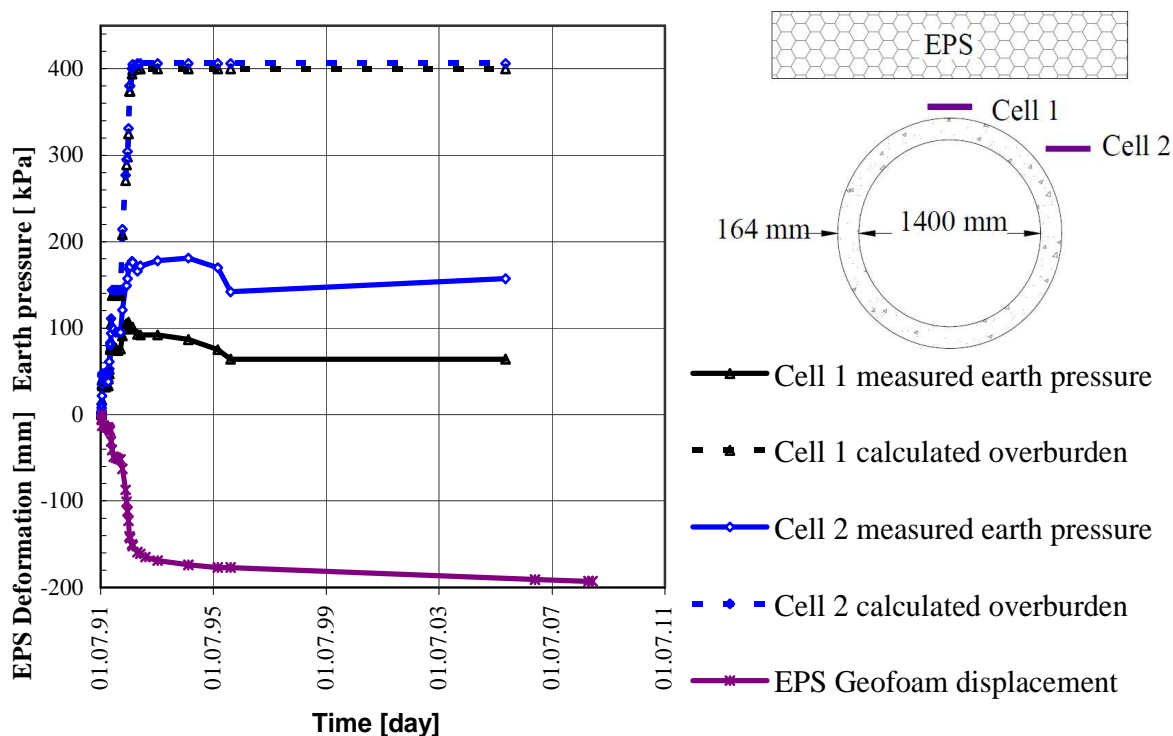

Figure 8 Vertical overburden pressures and deformation of EPS geofoam block

The measured vertical deformation of EPS geofoam is shown in Figure 8. The deformation was about 16 cm at the full fill height of the embankment, October 1992, which is about 32 % of the initial thickness of the EPS block. No significant change of deformation was registered after the end of the construction. The result shows the deformation was about 38 % in 2007. Much of the

deformation occurred during the construction stage and no settlement has been observed on the existing road above the embankment. This instrumented structure has been analysed with PLAXIS FEM program, Vaslestad et al. (2009).

COMPARISON

The long-term measured vertical pressure above the crown of the pipe ranged from 23 % to 25 % of the overburden pressure for installations with granular backfill material and about 45 % for the one with cohesive soil backfill. It has been noticed that the performance of induced arching is largely affected by the type of soil used in the embankment construction. The field installations with granular fill reduced the vertical pressure over the culvert more than the one with silty-clay embankment. The result also shows that the deformation of the EPS in cohesive fill is greater than in granular fills. However, the measured earth pressure for the section of culvert without induced trench installation showed 124 % of the overburden pressure. Figures 9 and 10 provide the quantitative comparison between the calculated overburden and the registered vertical earth pressure values among all field installations discussed above. The resulting plot clearly shows that the use of induced trench installation successfully reduced the vertical pressure above the buried structure. The final compression of the EPS geofilm at the end of embankment construction ranged from 27 % to 32 % for concrete pipes with granular fill and 50 % for cast-in-situ box culvert with cohesive fill.

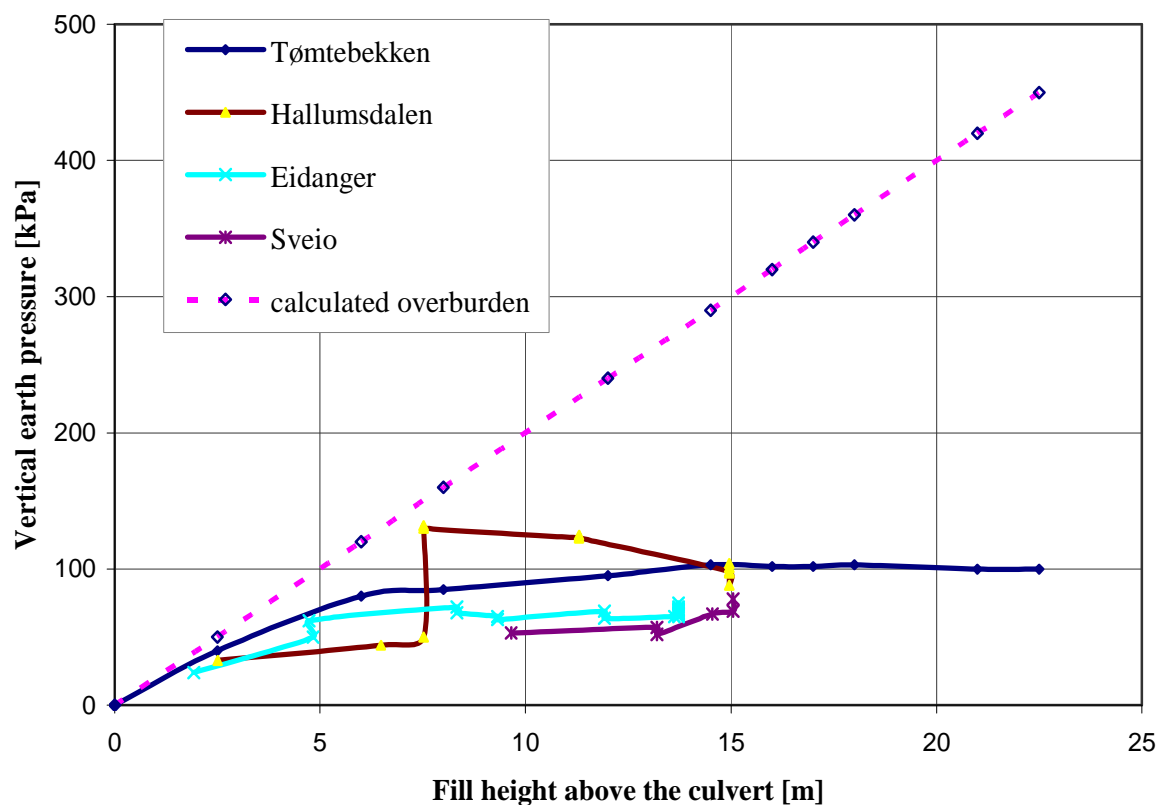

Figure 9 Measured vertical earth pressure vs the overburden pressure, γH

DESIGN METHOD

It may also be interesting to compare the result with the so called *the arching factor*. The vertical earth pressure, σ_v on an imperfect ditch culvert can be found from, Vaslestad (1990) as:

$$\sigma_v = N_A \gamma H \quad [\text{kN/m}^2]$$

Where

N_A = arching factor

γ = unit weight of the soil [kN/m^3]

H = height of cover [m]

And $N_A = \frac{1-e^{-A}}{A}$ where $A = 2S_v \frac{H}{B}$ and B = width of culvert [m]

The friction number S_v was used by Janbu (1976) to determine friction on piles:

$$S_v = |r| \tan \rho K_A$$

Where $\tan \rho = f \tan \phi =$ mobilized soil friction, f = degree of mobilization, (ranges from 0-1),

$\tan \phi$ = soil friction $K_A =$ active earth pressure coefficient

$$K_A = \frac{1}{\left[\sqrt{1 + \tan^2 \rho} + \tan \rho \sqrt{1 - |r|} \right]^2}$$

The roughness ratio $r = \frac{(p'_A + c \tan \phi) \tan \delta}{(p'_A + c \tan \phi) \tan \rho} = \frac{\tan \delta}{\tan \rho} \leq 1$, where $\tan \rho = \frac{\tan \phi}{\gamma_M}$, c = cohesion,

p'_A = Active earth pressure, δ = inclination of front wall

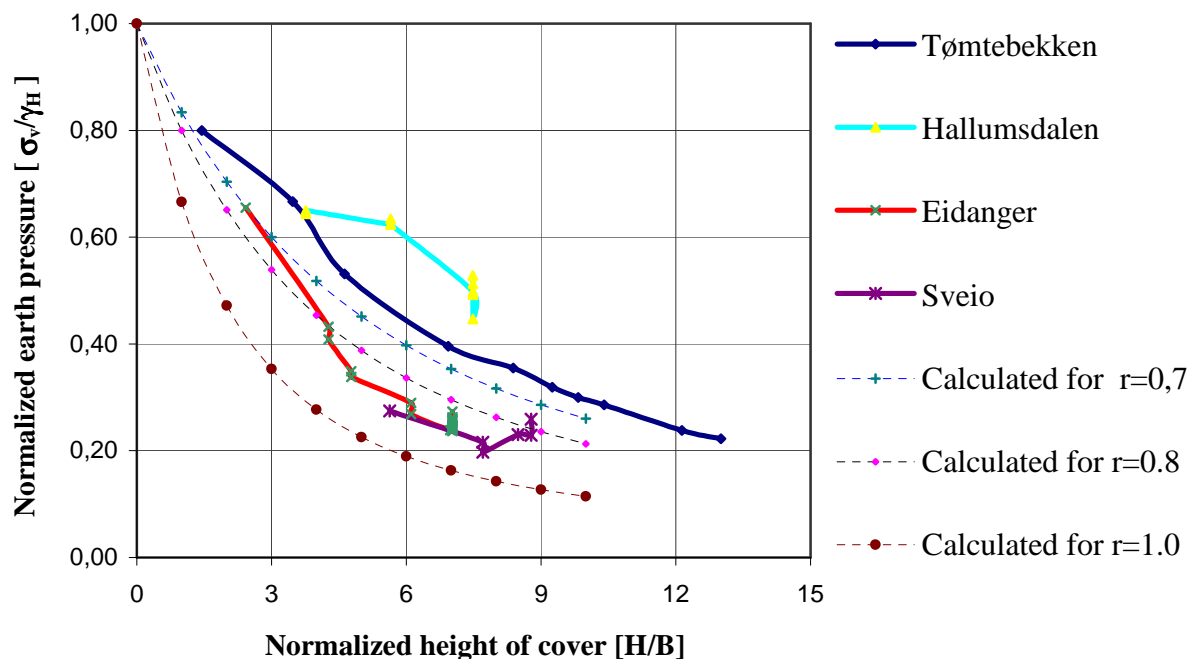

Figure 10 Comparison of the measured vertical earth pressure with the calculated arching factors

CONCLUSION

The induced trench installations described were successful in reducing the vertical loads on the buried culverts. The pressure on buried structures can be reduced with the appropriate selection

of back-fill material with higher stiffness like granular material. The average measured earth pressure above the crown of the pipe ranged from 23 % to 25 % of the overburden pressure for installations with granular backfill material and about 45 % for the one with cohesive backfill material. This shows the importance of using high quality well-compacted granular soil at the sides of an imperfect ditch culvert. The vertical earth pressure on the section without EPS geofam block was measured as 1.24 times the overburden pressure. The long-term full scale tests also showed that compression of the EPS geofam ranged from 28 % to 38 % for concrete pipes with granular fill and 54 % for cast-in-situ box culvert with cohesive fill. Long term monitoring of the field installations indicate no increased pressure or deformations on the buried culverts compared to the situation right after construction. Much of the deformation in the EPS block occurred during the construction phase and no problem has been observed on the road surfaces due to the long-term settlement of the expanded polystyrene. The measured vertical pressures are comparable with the design method.

REFERENCES

- Janbu, N. 1976. Static bearing capacity of friction piles. 6th European conference SMFE, Wein, proceegings, Volume III, pp 479-488.
- McAffee, R.P., & Valsangkar, A. J. 2008. Field performance, centerfuge test, and numerical modelling of an induced trench installation. Canadian Geotechnical Journal, 45(1) 85-101.
- Tadros, M.K. Benak,J.Y. A. M. Abdel-Karin A.M.and. Bexten.K. (1989) Field testing of a concrete box culvert. Transportation Research Record, Journal of the Transportation Research Board, No 1231, Transportation Research Board of the National Academies Washington D.C., 1989, pp. 39-54.
- Terzaghi, K. Theoretical soil mechanics. 1943. John Wiley and Sons, Inc.
- Vaslestad, J. 1991. Load reduction on buried rigid pipes below high embankments. ASCE Specialty Conference, Pipeline Division, Denver, Colorado, pp. 47-58.
- Vaslestad,J, Johansen T.H (2008) ” Arching on rigid structures below high fills. Long-term behaviour of three instrumented full scale tests”. Proceedings Nordic Geotetecnical Meeting nr 15, NGM 2008, 3.-6.september 2008, Sandefjord, Norway.
- Vaslestad, J., Yesuf, G.Y., Yohansen, T.H., Wendt, M. & Damtew, T. 2009. Instrumented field test and soil structure interaction of concrete pipe with high fill. Proceedings of the 17th international conference on Soil Mechanics and Geotechnical Engineering : *The Academia & Practice of Geotechnical Engineering*. 5-9 October 2009, Alexandria, Egypt, pp 1802-1805.
- Yang, X ., & Yongxing ,Z. 2005. Load reduction method and experimental study for culverts with thick backfills on roadways in mountainous regions. China Civil Engineering Journal, Vol.38, No 7, pp116-121.
- Zhang, W., Liu,B. & Xie, Y. 2006. Field test and numerical simulation study on the load reducing effect of EPS on the highly filled culvert. Journal of Highway and Transportation Research and Development, China., Vol. 23, No 12, pp 54-57.