

REBLOC® RB80A_8_H2/W1

Standard element

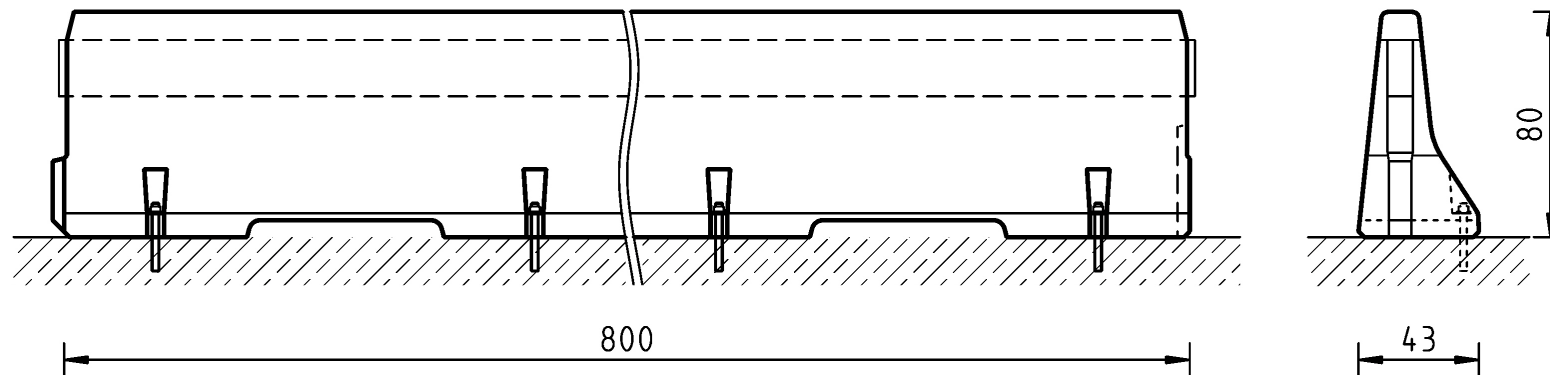

all dimensions in cm

Element	RB80A_8
Performance class (EN1317)	H2/W1/B
Dimensions L x W x H in cm	800 x 43 x 80 cm
Weight/element	3.700 kg
Drawing no.	6.0038
Date	2017-08-01

The element is connected by the integrated coupling, located at the face of the element.

REBLOC GmbH

Wiener Straße 662 · 3571 Gars/Kamp · Austria
Tel.: +43 (0) 2985 30528 2900
Fax: +43 (0) 2985 30528 2901
office@rebloc.com