

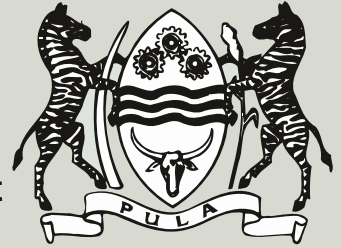

REPUBLIC OF BOTSWANA

ROADS DEPARTMENT

Ministry of Works, Transport
and Communications



Pavement Testing, Analysis and Interpretation of Test Data

Guideline no 2

May 2000

Pavement Testing, Analysis and Interpretation of Test Data

Ministry of Works, Transport & Communications,
Roads Department
Private Bag 0026
Gaborone, Botswana
Phone + 267 - 313511
Fax + 267 - 314278

MAY 2000

ISBN 99912 - 0 - 315 - X

Reproduction of extracts from this Guideline may be made subject to due acknowledgement of the source. Although this Guideline is believed to be correct at the time of printing, Roads Department does not accept any contractual, tortious or other form of liability for its contents or for any consequences arising from its use. Anyone using the information contained in the Guideline should apply their own skill and judgement to the particular issue under consideration.

ROADS DEPARTMENT

Under the policy direction of the Ministry of Works, Transport & Communications, Roads Department is responsible for providing an adequate, safe, cost-effective and efficient road infrastructure within the borders of Botswana as well as for facilitating cross-border road communications with neighbouring countries. Implied in these far-ranging responsibilities is the obligation to:

1. ensure that *existing roads are adequately maintained* in order to provide appropriate level of service for road users;
2. *improve existing roads* to required standards to enable them to carry prevailing levels of traffic with the required degree of safety;
3. *provide new roads* to the required geometric, pavement design and safety standards.

The Department has been vested with the strategic responsibility for overall management of the Public Highway Network (PHN) of some 18, 300 km of roads. This confers authority for setting of national specifications and standards and shared responsibility with the District Councils and Department of Wildlife and National Parks for the co-ordinated planning of the PHN.

Roads Department is also responsible for administering the relevant sections of the Public Roads Act, assisting local road authorities on technical matters and providing assistance in the national effort to promote citizen contractors in the road construction industry by giving technical advice wherever possible. This task is facilitated by the publication of a series of Technical Guidelines dealing with standards, general procedures and best practice on a variety of aspects of the planning, design, construction and maintenance of roads in Botswana that take full account of local conditions.

In its endeavour to provide uniformity of practice in the provision of efficient and effective road infrastructure, Roads Department has embarked on the preparation and publication of a number of Technical Guidelines. The main objective of these Guidelines is to document best practice and to preserve local knowledge on a variety of aspects of road planning, design, construction and maintenance that have evolved over many years in Botswana.

Guideline No. 1 The Design, Construction and Maintenance of Otta Seals (1999)

Guideline No. 2 Pavement Testing, Analysis and Interpretation of Test Data (2000)

FOREWORD

Pavement testing and interpretation of test data is a fundamental phenomenon in the proper monitoring and maintenance of road pavements in an economic way.

The first generation roads in Botswana have either reached, exceeded or are about to reach their design life and would require major rehabilitation. The traffic has increased tremendously on the Road Network, both in terms of number and axle loading, which means that the rehabilitation will require a considerable amount of funding. The optimal use of such funds will depend on the timely intervention of maintenance and rehabilitation using the most appropriate technology.

A significant proportion of the work of the Materials and Research Division of Roads Department involves both pavement field testing and the analysis and interpretation of pavement test data. This information is used for the determination of the pavement condition and maintenance requirements and to guide the road rehabilitation plans.

Hence, it is in recognition of the importance of accurate data collection and its interpretation that guidelines on the “Pavement Testing, Analysis and Interpretation of Test Data” had to be prepared in order to improve and streamline in-house capacity for pavement assessment and reporting as well as ensure continuous use of computer tools and analysis techniques used in the process, some of which were developed in-house.

Gaborone 15th May 2000



Andrew Nkaro
Acting Director of Roads

Roads Department

Ministry of Works, Transport and Communications

ACKNOWLEDGEMENTS

This Guideline is one of a series of Guidelines that is being compiled under the Institutional Co-operation Agreement that exists between the Roads Department and the Norwegian Public Roads Administration (NPRA). This Agreement falls under a NORAD Technical Assistance Programme to Roads Department that is co-funded by the Kingdom of Norway and the Government of the Republic of Botswana.

The production of the Guideline has been a joint project by Transportek-CSIR, Pretoria, Transport Research Laboratory (TRL), United Kingdom and Stewart Scott International (SSI) Inc. who was the consultant for the Working Group. The staff members involved were:

Dr Philip Paige-Green, CSIR

Dr Steve Kekwick, CSIR

Mr Colin Jones, TRL

Mr Harry Smith, TRL

Mr Philip Joubert, SSI

Mr Mihut Motrescu, SSI

The Working Group that guided the project and reviewed the Guideline, comprised of the following people:

Dr Bernard Obika, Roads Department

Mr Charles Overby, NPRA

Mr Barry Kemsley, Roads Department

Mr Baele Mmoloki, Roads Department

Mr Modise Segokgo, Roads Department

Mr Elliott Maswikiti, Roads Department

Mr Mogotsakgotla Kowa, Roads Department

Mr B Sharma, Roads Department

Photographs were provided by:

Charles Overby, NPRA

Transportek, CSIR

LIST OF ABBREVIATIONS

AASHTO	American Association of State Highway and Transportation Officials
BI	Bump Integrator
BLI	Base Layer Index
BRMS	Botswana Road Management System
CAM	Crack Activity Meter
CBR	California Bearing Ratio
CSIR	Council for Scientific and Industrial Research, South Africa
DCP	Dynamic Cone Penetrometer
DSN	DCP Structural Number over depth of 800 mm
EMC	Equilibrium Moisture Content
E80	Equivalent Standard Axle
FWD ⁸⁰⁰	Falling Weight Deflectometer
HDM	Highway Design and Maintenance (World Bank series)
HGV	Heavy Goods Vehicle
HSP	High Speed Profilometer
IDMP	Impuls Deflection Measurement Parameters
Im	Thornthwaites moisture index
IRI	International Roughness Index
LDI	Linear Displacement Integrator
LHS	Left Hand Side
LLI	Lower Layer Index
LS	Linear Shrinkage
MCCSSO	Moisture, Colour, Consistency, Structure, Soil type, Origin, used in Soil Profiling
MGV	Medium Goods Vehicle
MLI	Middle Layer Index
MR	Resilient Modulus
NAASR	National Association of Australian State Road Authorities
NORAD	Norwegian Agency for Development Co operation
NPRA	Norwegian Public Roads Administration
OMC	Optimum Moisture Content
PI	Plasticity Index
PL	Plastic Limit
PSI	Present Serviceability Index
PSR	Present Serviceability Rating
QI	Quartercar Index
RHS	Right Hand Side
RMS	Road Management System
RTRRMS	Response Type Road Roughness Measuring System
SAMDM	South African Mechanistic Design Method
SATCC	Southern Africa Transportation Communications Commission
SCRIM	Sideways-force Coefficient Routine Investigation Machine
SN	Structural Number
SNC	Modified Structural Number
SSI	Stewart Scott International
TMH	Technical Methods for Highways
TRH	Technical Recommendations for Highways
TRL	Transport Research Laboratory, United Kingdom
UCS	Unconfined Compressive Strength
VCI	Visual Condition Index
VHGV	Very Heavy Goods vehicle
VR	Roughness Values

TABLE OF CONTENTS

	page
Roads Department	3
Foreword	4
Acknowledgements	5

PART A GENERAL

1 INTRODUCTION

1.1 Background	14
1.2 Purpose and scope of Guideline	14
1.3 Structure of the Guideline	15

2 ROAD PAVEMENTS

2.1 The road function	16
2.2 Principles of road maintenance economics	16
2.3 Typical Pavement Structures	17
2.3.1 Surfacing.....	19
2.3.2 Pavement layers	19
2.3.3 Subgrade.....	19
2.3.4 Sealed/unsealed shoulders	19
2.4 The environment	20
2.5 Traffic loading	20

3 TYPES OF PAVEMENT DISTRESS

3.1 Causes and types of pavement distress	21
3.2 Roughness	23
3.3 Deformation	23
3.4 Cracking	24
3.5 Surface problems and surface texture	25
3.6 Pumping.....	26
3.7 Potholes and patching.....	26
3.8 Edge break	26
3.9 Moisture/drainage	26
3.10 Soluble salt damage	27

4 PLANNING AND SELECTION OF APPROPRIATE TESTING

4.1 Purpose of pavement evaluation	28
4.1.1 Structural evaluation	28
4.1.2 Functional evaluation	28
4.2 Existing information	28
4.2.1 As built data	29
4.2.2 Maintenance history	29
4.2.3 Historical traffic	29
4.2.4 Climatic records	30
4.3 Evaluation framework and selection of tests	30
4.3.1 Evaluation framework.....	30
4.3.2 Initial assessment	31
4.3.3 Detailed assessment	31
4.4 Test frequency	31

PART B EVALUATION METHODS page

5	VISUAL EVALUATION	
5.1	Methodology	35
5.2	Data collection	35
5.3	Analysis and presentation	37
6	RUT DEPTH MEASUREMENT	
6.1	General	38
6.2	Test procedures	38
6.3	Test frequency	38
6.4	Analysis and presentation	39
7	ROUGHNESS MEASUREMENT	
7.1	General	40
7.2	Test procedures	41
7.3	Test frequency	42
7.4	Analysis and presentation	42
8	PAVEMENT STRENGTH	
8.1	General	43
8.2	Deflection measurements	44
8.2.1	Type of equipment	44
8.2.2	Test procedures	45
8.2.3	Test frequency	45
8.2.4	Analysis and presentation	45
8.3	Dynamic Cone Penetrometer (DCP)	46
8.3.1	General	46
8.3.2	Test procedures	46
8.3.3	Test frequency	46
8.3.4	Analysis and presentation	46
9	TEST PIT PROFILING AND SAMPLING	
9.1	General	49
9.2	Location	49
9.3	Size and depth	50
9.4	In situ measurements	50
9.5	Description and logging of the soil profile	51
9.6	Analysis and presentation	52

PART C PAVEMENT DATA ANALYSIS

10	DATA ANALYSIS	
10.1	Data analysis phases and methodologies	54
10.2	Chainage adjustment	54
10.3	Identification of uniform section	56
10.4	Data evaluation	58
11	INTERPRETATION OF RESULTS	
11.1	Simple methods of data evaluation	59
11.2	Parameters obtained from analyses	59

11.3	Estimation of remaining life	60
11.4	Sensitivity analyses	61

PART D REFERENCES AND APPENDICES

	page
REFERENCES	63
APPENDICES	
Appendix A Visual evaluation forms and description	65
Appendix B Visual Condition Index (VCI)	67
Appendix C Roughness measurement	68
Appendix D Pavement layer strength coefficients for structural number (after Paterson, 1985).....	74
Appendix E Deflection measurement	75
Appendix F Test pit profiles	83
Appendix G Equilibrium and predicted moisture content	86
Appendix H Cumulative sum method for identifying uniform sections...	87
Appendix I Pavement condition rating form	95
Appendix J Definition of terms	96

LIST OF TABLES

	page
Table 2.1 Composition of typical Botswana bituminous pavements.....	18
Table 2.2 Typical surfacing lives in Botswana (years).....	19
Table 3.1 Typical distress types associated with performance.....	21
Table 3.2 Possible causes of traffic-associated distress.....	22
Table 3.3 Possible causes of non traffic-associated distress.....	23
Table 4.1 Typical pavement evaluation data requirements.....	30
Table 4.2 Suggested minimum testing and sampling frequencies.....	33
Table 5.1 Degree and description of distress modes.....	36
Table 5.2 Description of extent of distress.....	37
Table 7.1 Approximate comparison between IRI, QI and PSI (after Paterson, 1987).....	41
Table 10.1 Chainage adjustment.....	55
Table 11.1 Ranges of warning values for data interpretation.....	60
Table B1 Proposed weightings for VCI calculation (modified after TRH 22 ⁵).....	64
Table E1 Repeatability of duplicate transient deflection tests.....	75

Table H1	Possible uniform sectioning for deflection data.....	84
Table H2	Summary of deflection analysis.....	87

LIST OF FIGURES

page

Figure 2.1		
a-b	Illustration of various design strategies on maintenance and rehabilitation needs.....	17
Figure 2.2	Cross section terms and elements.....	17
Figure 2.3	Schematic illustration of various types of bituminous surfacings.....	18
Figure 6.1	Example of relationship between deflection and rut depth.....	39
Figure 10.1	Delineation of sections using as-built approach.....	57
Figure C1	Operation of MERLIN.....	65
Figure C2	Merlin data collection form.....	67
Figure C3	Diagrammatical representation of the TRL Integrator Unit fitted to a vehicle.....	69
Figure E1	Simplified pavements structure model.....	72
Figure E2	Diagrammatic representation of the Benkelman beam.....	73
Figure E3	Diagrammatic representation of the FWD.....	77
Figure E4	Deflection bowl parameters.....	79
Figure H1	Data and plots for Example 1.....	84
Figure H2	Deflection data example.....	87
Figure H3	Outer wheel path data and 90 th percentile characteristics deflections.....	89
Figure I1	Pavement condition rating form.....	91

LAYOUT OF THE GUIDELINE

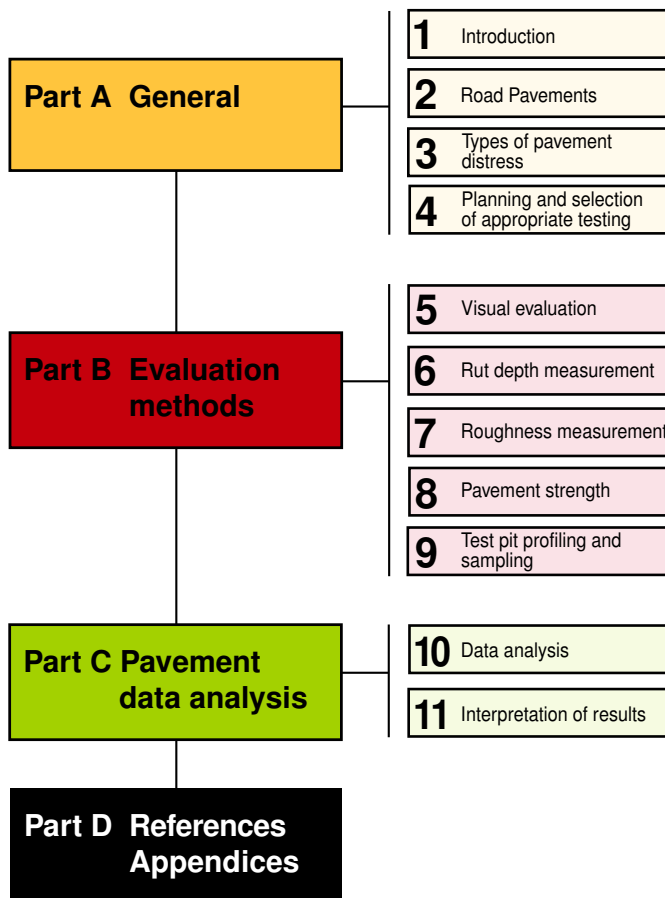



PART A GENERAL

- 1 Introduction
- 2 Road Pavements
- 3 Types of pavement distress
- 4 Planning and selection of appropriate testing

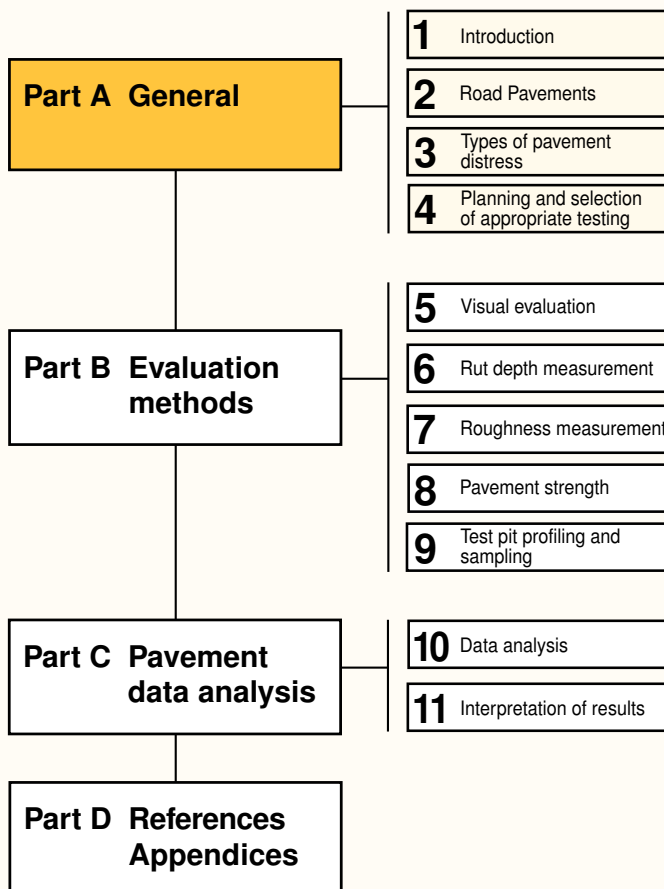

1 INTRODUCTION

1.1 Background

Traffic is usually defined in terms of equivalent 80 kN standard axles (E80). This is the number of 80 kN single axle loads that would cause the same damage to a pavement as the actual axle loads using the pavement.

The need for rehabilitation of a road is usually identified from the Road Management System which shows increased deterioration of the pavement in terms of its condition or maintenance requirement.

The consequences of incorrect decisions in regard to pavement evaluations can significantly affect the ultimate rehabilitation design.



New road - one year after construction.



Typical sign of pavement distress in the form of outer wheel path failures.



A road section due to be rehabilitated after many years in service.

All roads are designed with a finite life, usually defined by the traffic that the road can carry in terms of the cumulative number of equivalent standard axles (E80s). Once this design traffic has been carried, or as a result of premature distress caused by some environmental influence, the road usually needs to be rehabilitated.

Prior to any rehabilitation design being carried out, it is necessary to fully assess and evaluate the condition of the road pavement and to identify the reasons for the distress. The time and resources required for these types of investigation are generally limited and costly and thus it is essential that the appropriate information be gathered and that it is presented in a systematic and complete manner.

The primary reasons for undertaking pavement evaluations are to obtain information:

- on the pavement condition;
- on the remaining life of the pavement;
- for research and development purposes;
- to assess newly built roads.

Botswana is at the stage that many of the roads constructed during the late 1970s and early 1980s currently require, or will soon require, rehabilitation. An increased need for pavement evaluation studies and rehabilitation designs is thus envisaged.

1.2 Purpose and scope of guideline

The main purpose of this Guideline is to capture the knowledge and practice that have been built up in Botswana (and elsewhere in the region where relevant) with respect to the evaluation of pavements. It provides practical guidance on pavement evaluations and discusses the necessary techniques and processes to carry them out correctly and cost-effectively and to present the results in a standard and user-friendly format.

This Guideline should be used for the purpose intended, i.e. as a guideline, and should not be used as a prescriptive approach, as the evaluation requirements of each project are unique. The purpose of this guideline is to assist the Botswana Roads Department staff in designing, carrying out and presenting and interpreting the results of a pavement evaluation in a manner that will provide the most useful results in a concise and cost-effective manner.

The Guideline is intended for use mainly by the staff of the Central Materials Laboratory, Botswana Roads Department. It will also be important in the preparation of Terms of Reference for pavement evaluations of sealed roads.



1.3 Structure of the guideline

The guideline is structured in four main sections:

PART A (Theoretical aspects)

The *introduction* that is given in this section is followed by a general overview of road pavements in *Section 2* and types of distress in *Section 3*. The planning of pavement evaluations including the selection of the appropriate testing is discussed in *Section 4*.

PART B (Practical aspects)

Sections 5 to 9 summarise the test methods and techniques for the analysis and presentation of the data. Each test technique, including:

- visual evaluation;
- rut depth measurement;
- roughness evaluation;
- pavement strength investigation;
- test pit profiling

is discussed individually.

PART C (Analytical aspects)

In *Section 10*, the data analysis and evaluation procedure is outlined and in *Section 11* simple preliminary methods for the interpretation of the data collected are presented.

The process discussed in this guideline is summarised in the flow chart below.

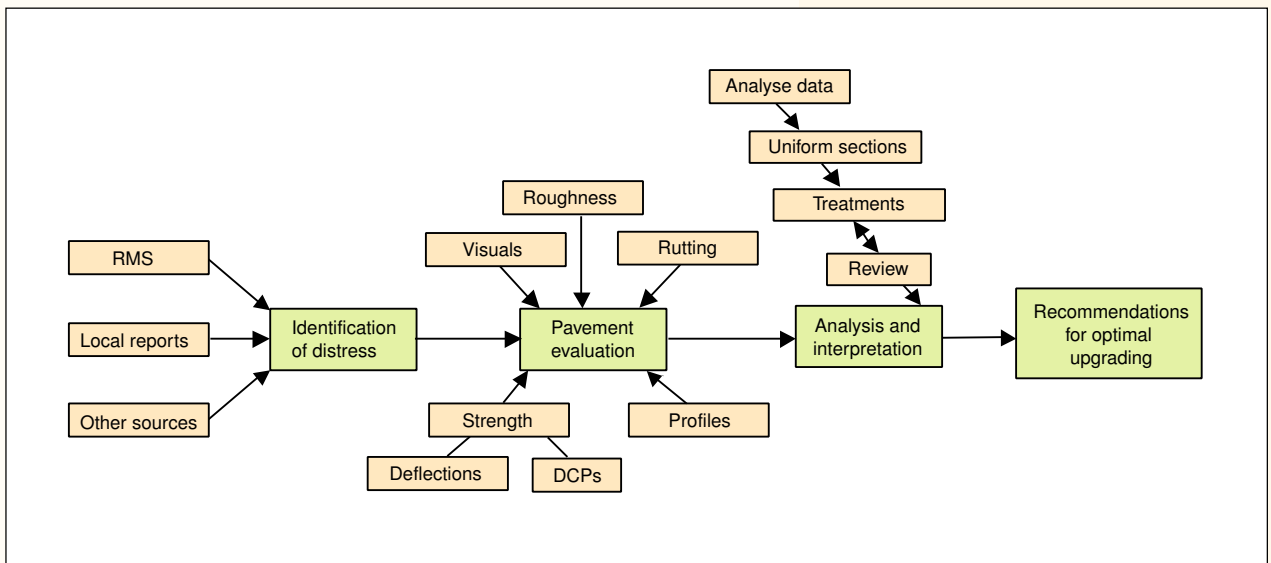

Different evaluation techniques are necessary for sealed and unsealed roads. This Guideline is specifically intended for use with sealed roads.

PART D (References and Appendices)

Part D includes the References and Appendices. More detailed information and standard data collection forms are also provided.

2 ROAD PAVEMENTS

2.1 The road function

Roads are constructed to perform a service to the road user. In this context, the road needs to provide good trafficability/passability under all weather conditions with maximum comfort and at minimum cost and with the highest possible degree of safety. This is defined as the *functional* performance of the road. The functional performance includes aspects such as the riding quality, the skid resistance and the effective drainage of water from the pavement surface.

The engineer, whilst recognising these functional requirements, regards the pavement as a load bearing structure that is required to perform under the prevailing traffic and environmental conditions with minimum maintenance. These aspects are considered as the *structural* requirements of the road.

Roads are designed to provide a specific service in terms of their carrying capacity under the expected pavement moisture regime and maintenance programme. Any overstressing of the pavement by traffic or reduction in the load-bearing capacity as a result of excessive ingress of water into the pavement layers and subgrade can result in structural failure of the pavement.

Functional and structural performance are two different aspects of road performance, which are not necessarily related.



Adequate drainage of the pavement layers and subgrade is essential for good pavement performance.

2.2 Principles of road maintenance economics

The economics of road maintenance revolve around optimising the total cost of construction, maintenance and rehabilitation for a particular road over a specific period. The concepts of analysis period and design period require careful consideration during the pavement design phase. The analysis period is a planning period during which full reconstruction of the pavement is undesirable and is a function of the road category but is also frequently related to the roads' *geometric life*. Where the traffic situation on a road is likely to change considerably in the short term, a short analysis period will be used.

The structural design period is a period during which it is predicted with a high degree of certainty that no structural failure will occur and no structural maintenance will be required.

If no rehabilitation is planned within the analysis period, the analysis and design period are the same. There will, however, always be maintenance requirements, mostly resealing, within the structural design period, which, if not carried out timeously or to the required quality, could result in premature structural failure of the pavement.

These aspects are illustrated in Figure 2.1. The *total life cycle cost* of the road over the analysis period is clearly a function of carrying out the correct maintenance at the correct time. Figure 2.1 (A) shows a design strategy that allows for a resurfacing and structural rehabilitation, which if the resurfacing is neglected or delayed will result in premature failure. The strategy illustrated in Figure 2.1 (B) allows the riding quality of the road to deteriorate to a greater degree with time and relies on three resurfacings to ensure that premature structural failure through water ingress does not occur.

Reseals using sprayed bituminous surface treatments are not regarded as structural maintenance.

The total life cycle costs of these different options could differ significantly. Accurate cost comparisons using vehicle operating costs and construction. Rehabilitation costs with prevailing discount rates for each project are therefore essential during the design stage.

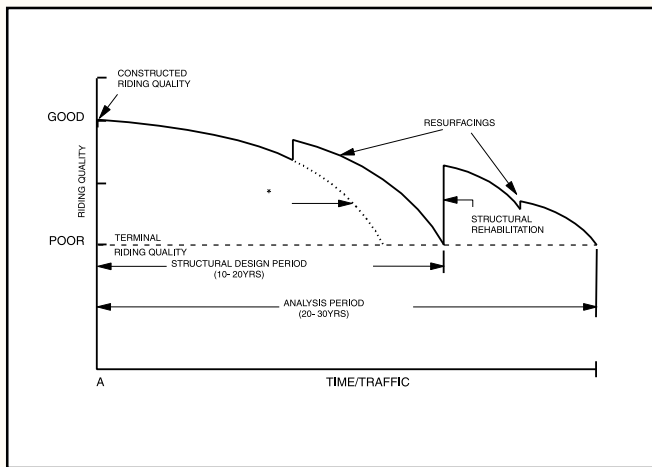

(a)

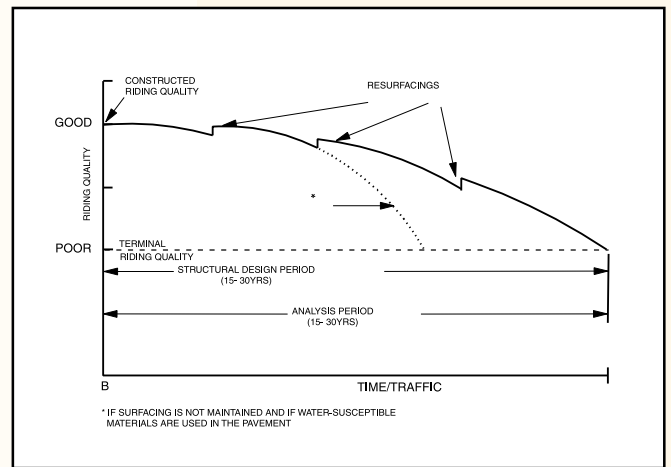

(b)

Figure 2.1 a + b. Illustration of various design strategies on maintenance and rehabilitation needs.

2.3 Typical pavement structures

A typical pavement cross-section is illustrated in Figure 2.2 where terms and elements are described. The terminology used in this Guideline is defined in Appendix J.

Cross section terms

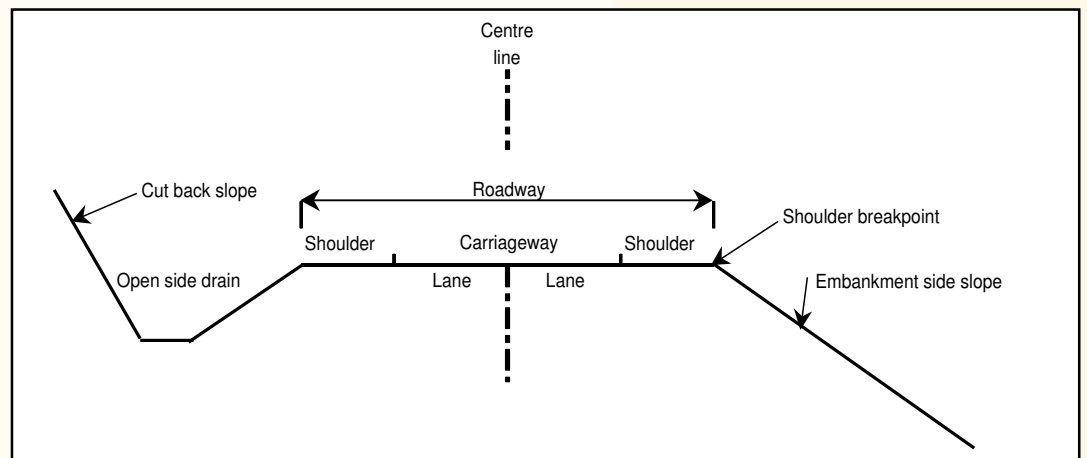

Cross section elements

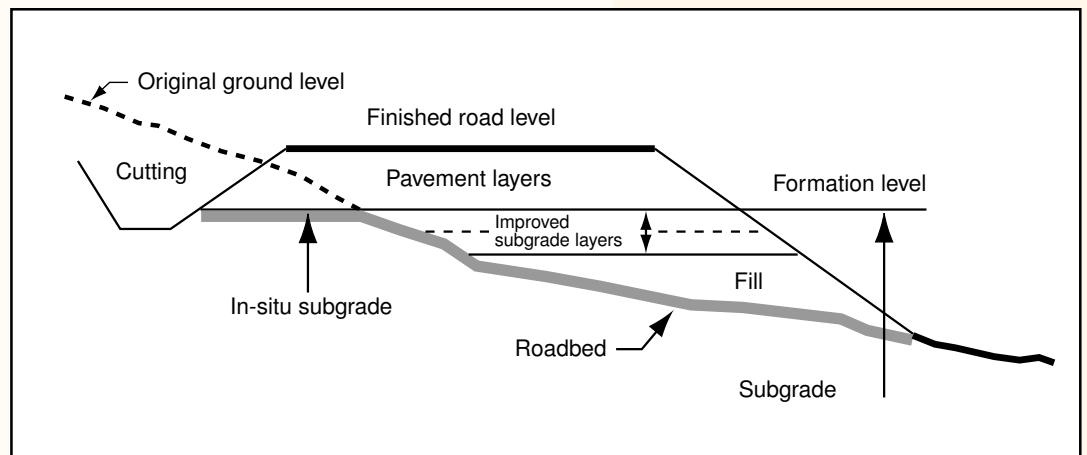

Figure 2.2 Cross section terms and elements.



The common bituminous pavement structures used in Botswana consist of a combination of layers composed of the various materials (Table 2.1). It is, however, clear that the pavement structure can comprise a wide number of permutations. It should be noted that various modes of distress are particularly associated with specific pavement structures, e.g. block cracking with stabilised bases, shrinkage cracking of asphalts, etc.

Surfacing	Asphalt, bituminous surface treatment
Base	Crushed stone, natural gravel, stabilised aggregate or gravel
Subbase	Crushed stone, natural gravel, stabilised aggregate or gravel
Selected layers	Natural or stabilised gravel

Note: Stabilised material binders include pozzolans (lime, cement etc.) and bitumens (penetration grades, emulsions, cutbacks etc.)

Table 2.1 Composition of typical Botswana bituminous pavements.

2.3.1 Surfacing

Various bituminous surfacings are available for use on roads (Figure 2.3). The choice of the most appropriate surfacing type is usually based on the life-cycle costs of the different surfacings, i.e. it is a function of their initial construction cost and their effective service lives. However, aspects such as the local maintenance capability, grade of the road, stiffness of the pavement structure and traffic need to be considered during selection of the surfacing type. A guide to typical surfacings and their expected lives is shown in Table 2.2

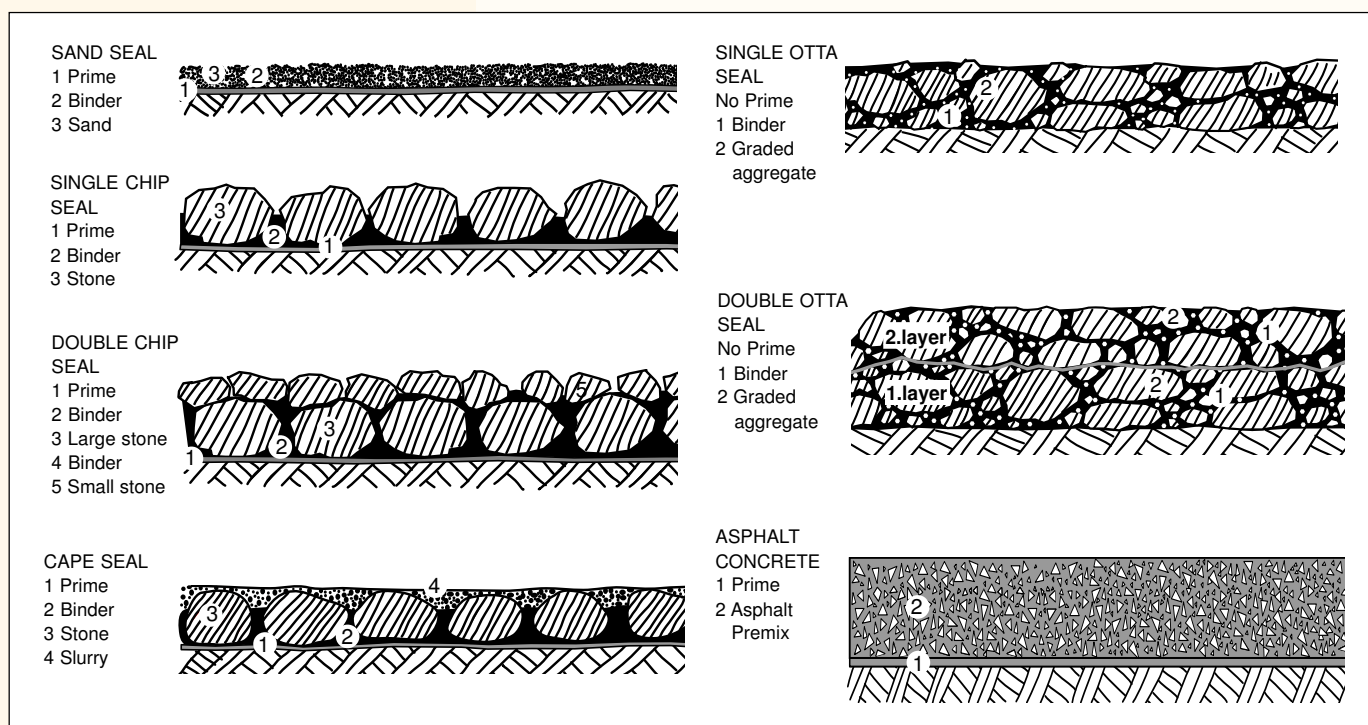

Fig 2.3 Schematic illustration of various types of bituminous surfacings.



Surfacing	Poor conditions	Good conditions
Asphalt (hot mix)	10 - 14	15 - 20
Double seal	6 - 8	9 - 13
Single seal	4 - 6	5 - 9
Double Otta seal	7 - 10	12 - 15
Single Otta seal + sand seal	7 - 9	9 - 11
Double sand seal	5 - 7	7 - 11

Table 2.2 Typical surfacing lives in Botswana (years).

2.3.2 Pavement layers

The pavement layers provide the load-spreading capability of the pavement and are constructed from selected processed, natural or stabilised materials. The base, subbase and selected layers comprise the pavement layers and are generally specified in terms of a strength requirement at a specified moisture content and compaction effort. If all the layers are unstabilised, the stiffness/strength will decrease systematically from the base to the lower selected layer. If the subbase is stabilised, it is usually stiffer and stronger than the base. Stabilised subbases are usually used to provide a sound working platform when natural materials are poor (low CBR), and to ensure that the compaction required for high quality bases is obtained. The problem of reflection cracking in the surfacing associated with stabilised bases has resulted in a reduction in their use, but specific circumstances (usually the lack of suitable base materials) may necessitate their use.

Sealing and careful maintenance of stabilisation (reflection) cracks can negate the problem of water ingress into the pavement and allow the use of stabilised bases.

2.3.3 Subgrade

The subgrade materials are those in situ. They are usually improved by ripping and recompacting to provide a uniform layer, and reduce material variation in strength, which is undesirable and may lead to local pavement distress. Subgrades are normally classified in terms of CBR, and the overlying pavement structure is designed to limit stresses (and deformations) in the subgrade.

2.3.4 Sealed/unsealed shoulders

From both a safety and a structural point of view, the road shoulders adjacent to the carriageway are extremely important. Gravel/unsealed shoulders are usually less costly to construct but require material of a specific quality for optimal performance and must be maintained regularly. Poor material and maintenance results in unsafe conditions, particularly when the drop-off between the seal and the gravel becomes large. Unsealed shoulders, if poorly maintained, can have a major influence on the pavement drainage as a result of ponding of water adjacent to the seal and subsequent seepage into the pavement base. Sealed shoulders are initially more costly to construct but have the advantage of reducing water access into the structural layers of the pavement and providing safer conditions for the motorist. A frequent problem with sealed shoulders is that they are used as an extra lane by slow moving vehicles and, if they are structurally inadequate (i.e. not built to the



Road with sealed shoulders.



Road with unsealed shoulders.



same standard as the rest of the pavement), will require substantial maintenance.

2.4 The environment

Environmental influences such as the climate, including rainfall and temperature, in situ material (i.e. subgrade) thickness, nature and condition and regional moisture and drainage conditions play an important part in the performance of the road structure. The subgrade material must be brought to a standard where it is uniform and has adequate strength to support the expected traffic loading (see section 2.5). This is usually achieved by mechanical improvement of the in situ material (ripping and recompaction) or importation of a better quality material.

Climate has a significant effect on the road structure, particularly in terms of the precipitation. High rainfall or periods of concentrated rainfall can result in changes in the moisture content of the pavement and subgrade materials, which under poor drainage conditions can detrimentally affect the pavement structure. Particular note needs to be taken of perched water tables where moisture often moves beneath the road and leads to structural deterioration of the pavement under traffic loading.

2.5 Traffic loading

A pavement is designed to carry a pre-determined number of standard loaded axles before structural rehabilitation is necessary. An increase in the traffic as a result of higher growth rates than predicted or excessive diversion of traffic from other routes shortens the life of the road. Of greater consequence, however, is the effect of overloaded vehicles. Damage caused to pavements increases exponentially with axle load. A 10 per cent axle overload can therefore cause some 50 per cent more damage than the legal load, while a 20 per cent axle overload can more than double the damage that the legal axle load would cause. Other factors such as the tyre configurations and pressures also have a major impact on the stress distribution on the pavement and can result in localised distress.



Grass and bushes should not be allowed to grow close to the surfaced area, as this will have a negative influence on the pavement performance.

Perched water tables are caused by any low permeability material (e.g. calcrete, silcrete, ferricrete, clay, etc.), beneath the natural ground surface, which impedes drainage and results in a build-up of moisture in the material adjacent to the road. Specific problems related to perched water tables have been recorded on the Nata-Gweta and the Tutume-Maitengwe roads.



Overloaded vehicles are a major cause of premature distress due to the exponential effect of load on pavement damage. Hence the pavement life can be significantly reduced.



Pavement distress, shown as excessive rutting.



3 TYPES OF PAVEMENT DISTRESS

3.1 Causes and types of pavement distress

The structural failure of a pavement is usually manifested as rutting, cracking, ravelling and/or shear failure in the pavement. The process is often self-perpetuating in that the development of distress allows the ingress of water into the pavement exacerbating the conditions that may have initially led to the cracking.

The need for a pavement evaluation is usually determined by the structural performance of the pavement. Functional characteristics are generally controlled by ongoing maintenance activities whereas structural defects indicate potential structural problems and require more costly intervention. The typical distress types associated with functional and structural performance are summarised in Table 3.1.

Performance	Distress type
Functional	Riding quality Skid resistance Surface drainage
Structural	Deformation Cracking Surface disintegration

Table 3.1 Typical distress types associated with performance.

The distress or expected mode of failure of pavements is a function of the type of pavement. This is primarily related to the subbase, base and surfacing type. Stabilised materials behave in a different manner to granular materials, and asphaltic concrete behaves differently to thin bituminous seals.

Typical distress modes discussed are:

- granular layers: shear failure and deformation/rut;
- stabilised layers: wider-spaced cracking (> 1 m), surface crushing;
- asphalt concrete: closer-spaced cracking (< 1 m), rutting.

Granular materials usually fail in shear because of their shear strength being exceeded by the applied load. This is generally the result of excessive water in the pavement, which reduces the shear strength of the material. Granular materials are also prone to plastic deformation under load. This results in the gradual development of ruts, either due to compaction shown up by traffic compaction or else by non-reversible plastic strain under load.

Stabilised materials are initially far more rigid than granular materials and fail in tension if overloaded with inadequate support. In time, stabilised material cracks under loading or due to shrinkage and therefore behaves more like a granular material. This need not necessarily result in any distress of the pavement. The shrinkage cracking associated with strongly stabilised

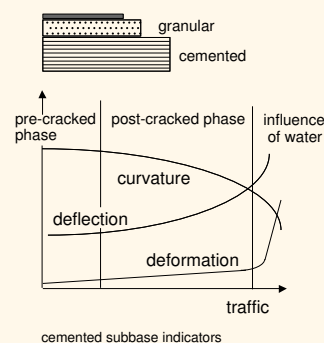
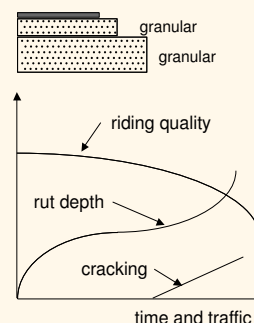

The consequences of deformation occurring are more severe than cracking, since the useful life of the pavement can be considerably prolonged if cracks are attended to in time and kept sealed.

Pavements where only the base course is cemented with granular subbase are sensitive to high axle loading and loss of strength by ingress of water through surface cracks.

It is particularly important that the first scheduled reseal is not missed or deferred due to the early development of block cracks in this pavement type.

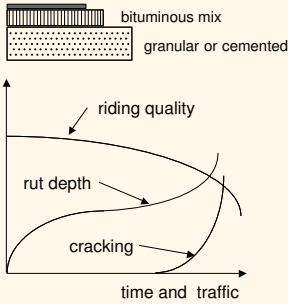

Roads with high traffic speed require a levelling layer made of bituminous mix in order to achieve good riding quality.

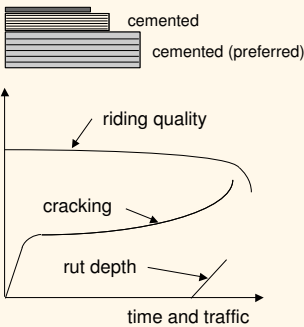

The use of stabilised layers in a pavement should be identified in any pavement evaluation as different behaviour can be expected.



Unstable premix causes shoving.

materials has led to a significant reduction in the use of stabilised materials in the base course. Stabilised subbases are, however, very common as are weakly stabilised selected layers to improve material quality in the lower layers of pavements.

Thin bituminous seals are not considered to be structural layers within the pavement but only waterproof the base and protect it from traffic action. Distress of the surfacing usually reflects the performance of the underlying road structure, particularly the top of the base to which the seal is bonded.

Asphalt concrete on the other hand, is considered as a structural pavement layer. It is a relatively stiff material, particularly under low temperature conditions, and its performance is thus related to the deflection of the pavement. High deflections will result in fatigue failure and extensive cracking. Environmental influences such as drying and ultra-violet radiation harden the binder with time and thereby increase its stiffness, making it more susceptible to cracking under traffic loading. High surface temperatures, wheel loads and wheel contact pressures may also result in permanent deformation (rutting) of the asphalt mix.

It is possible to obtain a preliminary indication of the possible causes of distress in a pavement from a simple visual evaluation. A distinction must be made between traffic and non-traffic associated distress. Traffic associated distress is usually restricted to the wheel paths while non-traffic-associated distress tends to occur over the full width of the road or occurs at the pavement edges and adjacent to culverts. Table 3.2 indicates possible causes of traffic-associated distress.

Distress type	Possible cause
Cracking : Longitudinal	Subgrade problems, poor construction.
Crocodile	Fatigue failure of surfacing or base. Poor drainage/high moisture content. Poor bond under bituminous surfacing.
Rutting	Insufficient compaction of subgrade. Insufficient compaction of pavement layers. Insufficient pavement strength. Shear failure of bituminous surfacing or granular base.
Bleeding/flushing	Excessive application of bitumen. Soft base resulting in punching of aggregate.
Pumping	Moisture/drainage problems with significant movement in upper pavement layers.
Ravelling of surface	Insufficient or dry binder. Poor aggregate adhesion.
Surface potholes	Poor bonding to base. Disintegration of weak aggregate. Salt damage. Vehicular damage. Spalling around cracks.
Deep potholes (into base)	Insufficient shear strength of base or subbase. Excessive moisture.

Table 3.2 Possible causes of traffic-associated distress.

Typical examples of non traffic-associated distress and their potential causes are summarised in Table 3.3.



Distress type	Possible cause
Longitudinal cracking	Shrinkage through ageing. Reflection of stabilisation cracks from base or subbase. Shrinkage of natural gravels through drying or self cementation. Volumetric movement beneath shoulder (expansive clays). Settlement of fill.
Transverse cracking	Shrinkage of asphalt through ageing. Reflection of stabilisation cracks from base or subbase. Volumetric shrinkage associated with leaking culvert. Shrinkage of natural gravels through drying or self cementation. Tearing by paver or steel wheeled rollers (asphalt). Settlement at culvert or structures.
Block cracking	Shrinkage through ageing. Reflection of stabilisation cracks from base or subbase.
Map cracking	Shrinkage through ageing of surfacing.
Star cracking	Soluble salt blistering. Water vapour blisters. Chemical reactions.
Surface irregularities	Collapsible sand. Expansive soil. Subsoil mole or insect activity.
Deep potholes (into base)	Insufficient shear strength of base or subbase. Excessive moisture.

Table 3.3 Possible causes of non traffic-associated distress.

3.2 Roughness

The roughness of a road is the longitudinal irregularity of the wheel paths of the road that affects the riding quality and the dynamics of moving vehicles. The road roughness also has a significant impact on the operating costs of vehicles making use of the road. Surface roughness, as well as rutting, can also have a major influence on the drainage of water from the pavement surface. Although primarily a functional characteristic of roads, the surface roughness is often indicative of structural deficiencies.

Significant increases in roughness are normally associated with structural deterioration and indicate the need for a more comprehensive evaluation.

3.3 Deformation

Rutting is the most common manifestation of deformation and indicates plastic deformation of the pavement layers and/or subgrade under repeated traffic loading. Rutting is restricted to wheel paths.

The shape of the rut gives a useful first indication of the pavement layers that are likely to have caused the rutting. A wide, evenshaped rut is typically indicative of problems in the lower layers and narrow more sharply defined ruts are usually caused by problems in the upper pavement layers.

Other typical forms of deformation include depressions and mounds, displacements, corrugations and undulations, all manifested as deviations of the road surface from a uniform flat condition and having a detrimental effect on the riding quality. Deformation often results from subgrade and

construction deficiencies and is frequently associated with culverts and embankments. Shoving of asphaltic concrete surfacings under traffic is also a common cause of surface deformation.

3.4 Cracking

The onset of cracking is a primary cause of subsequent rapid deterioration of a pavement, principally due to ingress of moisture and weakening of pavement layers, which is why its identification and treatment is a key component of any pavement evaluation. Different forms of cracking can be due to different fundamental causes, so it is vital in the visual evaluation to identify the types of cracking. For practical purposes, four different forms of cracking are defined, as indicated in the following sections.

I. Crocodile and Map cracking

Traffic-associated crocodile cracking (interconnected polygons less than 300 mm diameter) normally starts in the wheel paths as short longitudinal cracks. With thin surfacings, this progresses through star and map cracking (interconnected polygons more than 300 mm diameter) to crocodile cracking. With thicker surfacings or asphalt bases, the cracks generally propagate further along the wheel path before secondary cracks form, resulting in the familiar map pattern.

II. Block cracking

Block cracking is usually caused by the shrinkage of stabilised layers. These cracks are not confined to the wheel paths. The distress initially appears in the form of longitudinal or transverse cracks and develops into block cracking. The spacing between these block cracks largely depends on the type of material, the thickness of the pavement layer and the shrinkage characteristics of the stabilizing agent. Although traffic loading does not initiate this distress, it tends to cause secondary cracking, which may eventually become crocodile cracking.

III. Longitudinal cracking

Poor construction techniques often cause longitudinal cracking. These include poor construction joints and segregation of materials during construction. These problems are visually easily detectable and should be identified during the detailed visual inspection.

IV. Transverse cracking

Transverse cracking is usually caused by temperature-associated distress. This cracking is thus not usually directly associated with structural problems, but it can initiate further deterioration if the ingress of surface water occurs.

Shrinkage cracking of the asphalt surfacing is indicative of asphalt that does not respond easily to changes in temperature, i.e. mostly dry and stiff asphalt. Older pavements are usually more susceptible to this form of cracking. The closing of these cracks in the wheel paths through the effect of trafficking is an indication that the problem may be limited to the surface layer only.



Crocodile cracking and associated shoving.



Typical map cracking.



Block cracks resulting from stabilised base. They have been well sealed to prevent water ingress.



Swelling of subgrades or settlement of embankments may also cause longitudinal cracking. Such cracks are not confined to the wheel paths and are often found near the shoulders of the pavement.



Transverse cracking is very common and is usually caused by temperature-associated distress.



In some cases, it may be necessary to quantify the extent of the cracking but this is not usually necessary for routine pavement evaluations. Quantification is most conveniently carried out by expressing the cracking as a percentage of the surface area over a defined length of road or lane. Crack intensity is a measure of the total length of cracking per unit area (m/m^2). A method currently in use is to quantify the cracked area as the sum of rectangular areas surrounding individual cracking networks in square metres as a percentage of the subsection area. For linear cracks, the area is defined by a 0.5 metre wide strip extending the length of the crack¹. It is also possible to quantify movement associated with cracks using the Crack Activity Meter (CAM) but this is considered to be more of a research tool.

The visual assessment should classify observed cracks in the four categories, crocodile/map, block, longitudinal, transverse.

In the BRMS cracking is classified as “all cracks” and “wide cracks”. For pavement evaluation purposes, however, it is more important to record the type of cracking with a classification of its severity and extent as discussed previously.

3.5 Surfacing problems and surface texture

Pavements may be structurally adequate but may have problems with the surfacing. The visual survey must therefore identify surfacing problems, and the later deflection and DCP data processing will clarify whether there are underlying structural problems. Main surface defects to be identified are:

- disintegration or ravelling;
- bleeding or polishing.

Ravelling is manifested as loss of adhesion between the stone in the seal and the binder. If this occurs because of water, it is defined as stripping. Inspection of the loose material generated during ravelling will indicate which process occurred. Stripped aggregate is clean while ravelled aggregate is coated with binder. Disintegration of aggregate (as a result of inadequate hardness or durability) is often manifested as ravelling.

Bleeding is a manifestation of excessive bitumen, either as a result of too much being applied during construction or a change in the effective aggregate gradation resulting from disintegration of the aggregate or embedment in the base under traffic. Polishing of the aggregate is usually associated with specific aggregate types that wear evenly under traffic to form a smooth surface. This leads to a reduction in the skid-resistance of the pavement. These aspects primarily affect the functional behaviour of the road.

The edges of cracks, specifically those associated with stabilised and self-cementing materials, frequently spall under wheel loads. If left unchecked, this spalling develops into potholes.

The texture of road surfacings primarily affects the functional performance of roads in terms of their skid resistance, road noise and wheel-spray. Cracking of the seal may result from structural characteristics e.g. high deflections, or may be caused by environmental effects such as ageing attributable to ultra-violet damage or drying out (these are usually exacerbated by lack of maintenance). It is important to differentiate between these two aspects and this is best done by determining whether the distress is restricted to the wheel paths (structural problems) or whether it covers the entire road surface (environmental or maintenance problems).

The texture is usually described as part of the visual evaluation (Appendix A) but in certain instances, it may be necessary to quantify the surface friction. Apparatus such as the Portable Skid-resistance Tester (sometimes called a



Loss of stone from single seal.



Loss of surface texture as a result of bleeding (degree 5).

For certain types of surfacing and traffic conditions, the presence of bleeding may not necessarily be a problem. In general, surfacings that bleed will last longer than dry surfacings.

It should be noted that unmaintained ravelling and spalling would usually lead to water penetrating the base and the formation of potholes. A functional defect could thus lead to structural distress.



Pendulum tester to determine skid resistance.

A

Skid resistance determination can be carried out using commercial equipment e.g. SCRIM or Grip-tester, but this is seldom cost-effective or necessary for a limited pavement evaluation or where a resurfacing type remedial action is in any case identified.



The presence of pumping is a sign of serious deficiencies in the base layer and normally signals the onset of rapid deterioration.



Large patch but poorly executed resulting in failure.



Bad edge break.

Pendulum Tester) can be used to quantify the pavement friction but this equipment only measures a very small area of road and is more appropriate to localised accident investigations and laboratory work.

The surface texture can be measured using the sand-patch method. This type of testing is considered to be too specialised for routine pavement evaluations and would only be carried out on a project basis where it has been identified as a requirement.

3.6 Pumping

Pumping occurs when water pressures generated in the pavement by traffic loading cause water containing fine material to be ejected through cracks. It is usually manifested as discolouration of the surfacing associated with cracking and is indicative of a loss of fine material from the pavement. Pumping is most readily apparent just after rains, because the freshly pumped fines lie along the cracks and have not been dispersed by traffic. At other times, tell-tale discolouration around cracks can be a good indication of previous pumping.

3.7 Potholes and patching

Potholes are the result of loss of material from the base course once the surfacing has failed. Potholes are typically the result of pumping and loss of surfacing attributable to lack of maintenance. Potholes are distinguished from ravelling by being more than 150 mm in diameter and greater than 25 mm in depth. Patches indicate the location of potholes that have been maintained and are not necessarily defects, but give an indication of previous distress. Both potholes and patches are indicative of either material or drainage problems in or beneath the pavement and are a strong warning of impending structural deterioration.

3.8 Edge break

Edge breaks caused by the breaking away of the edge of the surfacing adjacent to the shoulder under traffic is mostly the result of poor shoulder maintenance. Edge break is more a functional problem than a structural problem but should be included in routine visual evaluations. Localised incidences are often associated with popular taxi pick-up/drop-off points. Extensive edge break is, however, a good indicator that the pavement is too narrow for the traffic being carried.

3.9 Moisture/drainage

The effect of excessive moisture in the pavement structure has been discussed (Sec 2.4) but bears repeating as it is probably the most important contributor to pavement failures. Excessive moisture in the pavement structure is generally the result of inadequate side-drainage, poor shoulders, unmaintained surface seals or a combination of these. High moisture contents in the pave-



ment materials result in a decrease in the material strength and stiffness as well as the development of excess pore-water pressures under load. Both of these conditions can result in shear failure of the material at stresses lower than those designed for.

It is generally accepted that the moisture content within a sealed pavement structure reaches an equilibrium value some time after construction². This can, however, be influenced by the drainage and maintenance. Irrespective of this, unless there is a well-maintained sealed shoulder, the moisture content beneath the outer wheel path can be expected to fluctuate significantly through the year. During any pavement evaluation, the expected pavement moisture regime in relation to the season should be recorded, particularly when DCP or deflection surveys are carried out.

Similarly, the rating of the drainage and its influence on the pavement moisture regime must be carefully evaluated and recorded. Suggestions for this are included in Appendix A.

During the rating of drainage particular attention should be paid to:

- condition of surface or sub-surface drains (if any);
- road camber;
- topography and geology of the surrounding area;
- vegetation in the immediate area.

These factors will help establish specific remedial needs for the section in the subsequent data processing and section analysis.

3.10 Soluble salt damage

Problems caused by soluble salts in semi-arid and arid areas are such that they deserve particular discussion. Soluble salt damage is manifested as blistering of the bituminous seal, star cracking, separation of the seal from the base course and eventually disintegration of the bituminous surfacing. The problems arise from the solution of soluble salts in the pavement layers or subgrade, migration through the pavement and crystallization beneath the surfacing when the moisture carrying them evaporates at the surface.



Inadequate maintenance of side drains.



Water ponding at the edge of the surfacing will weaken the pavement structure.

Drainage inadequacy is often the cause of localised areas of distress and the visual evaluation should identify such inadequacies and possible causes.



Salt damage to road surfacing.



Close up of salt blisters.

A

4 PLANNING AND SELECTION OF APPROPRIATE TESTING

4.1 Purpose of pavement evaluation

Prior to embarking on any pavement evaluation it is essential to understand the objective of the evaluation and to make use of evaluation techniques that will best achieve this objective. The primary objective of most evaluations that will be carried out will be to provide the input for rehabilitation designs (structural evaluation). Other objectives may include:

- evaluation of experimental road sections;
- ad hoc failure investigations, and
- post-construction pavement audits.

Planning of pavement evaluations must be aimed at satisfying the requirements of the specific evaluation. In addition to this the needs for a structural evaluation differ from those for a functional evaluation.

4.1.1 Structural evaluation

Structural evaluations are carried out to determine whether the pavement will carry the traffic it has been designed for and can be carried out at any time in the pavement's life. The remaining structural capacity can be determined and compared with the traffic that the pavement has carried, or is expected to carry over the remainder of its life.

Structural evaluations require an investigation of the strengths (and preferably stiffnesses) and thicknesses of the individual pavement layers as well as the overall interaction of the layers within the pavement structure. These evaluations thus require sophisticated testing of parameters such as deflections, deflection bowl parameters and detailed testing such as Dynamic Cone Penetrometer (DCP) profiles or test pits. Visual evaluations of cracking, disintegration and potholing are necessary inputs for a structural evaluation.

4.1.2 Functional evaluation

Functional evaluations identify the capability of the pavement structure to provide a comfortable and safe service to the road user. The primary parameters determined in functional evaluations are the riding quality, skid resistance and a visual evaluation of aspects such as potholes and edge break.

4.2 Existing information

Considerable amounts of information regarding any road project usually exist within the Roads Department. This includes:

- the original design;
- the as-built records or completion data;

This chapter highlights the minimum requirements for pavement evaluations.

Predictions of pavement life are highly dependent on accurate past traffic loadings. Wherever possible, therefore, the Roads Department should maintain a reliable record of regular traffic counts and, ideally, vehicle axle loads for its road network.



Visual inspection is of vital importance in addressing the pavement condition.



- traffic information;
- maintenance records;
- ad hoc reports, and of course
- data in the Road Management System.

Other information such as the climatic records over the life of the road can be obtained from the relevant source if necessary. Evaluation of these data is essential in order to plan the most effective evaluation procedure. Other documents in this series of Guidelines could also provide useful information.

4.2.1 As built data

The as-built and/or completion records should be compared with the original pavement and material design to ensure that the pavement was built to the original specification. Particular care should be paid to the layer thicknesses, material properties and in situ densities or compaction. Traffic information should be evaluated to investigate whether the traffic carried on the road was according to the design assumptions or whether there has been a significant change, especially in heavy or overloaded vehicles. A comparison of the condition of the pavement in the two directions of the road will often indicate whether loading has played a part in the pavement condition, as one lane may carry more loaded vehicles than the return lane.

4.2.2 Maintenance history

The type and frequency of maintenance carried out on the pavement is also a good first indication of the possible causes of distress on a road. Highly localised problems are often the result of poor pavement drainage or localised material/construction deficiencies, while large areas of rutting or cracking indicate excessive traffic and/or design or construction deficiencies. Similarly, ad-hoc reports would normally be produced because of some form of problem. These would usually identify one or more probable causes of the problem. It is also important to talk to the local staff (regional engineers, technicians and section heads), as valuable information may be available which has not been reported or documented.

The need for a pavement evaluation will frequently be identified during routine analysis of the road network using the Road Management System. This information is invaluable for determining the primary modes of distress and possible causes of failure.

4.2.3 Historical traffic

It is essential to evaluate all historical traffic records. These should include not only the number of vehicles, but also a break down into various categories (cars, BUSES and medium (MGV), heavy (HGV) and very heavy goods vehicles (VHGV)) and, if possible, details on the actual axle loads and distributions and growth rates. For studies of premature failures particularly, this is essential in order to determine whether the road has been overloaded either in terms of the cumulative equivalent standard axles or by occasional excessively heavy axles.



Different degrees of distress in different directions of traffic.



Localised structural problem.

Visual examination of the surfacing will usually allow the identification of past resealing activities. Typical maintenance actions in Botswana would be a fog spray after 2 to 3 years, a surface treatment after 5 to 7 years and then a slurry seal after 3 years.

A

Climatic records can be obtained from the Meteorological Institute, Gaborone.

4.2.4 Climatic records

The importance of moisture on the performance of pavement structures has been highlighted in this guideline. An evaluation of the rainfall records over the life of the road will indicate whether there have been significant deviations from the average quantity of precipitation in the area as well as information on the distribution of the rainfall. Although the rainfall may have been similar to the long-term annual average rainfall, the records may show that it was concentrated over a short period resulting in abnormal moisture conditions in the pavement. Records of precipitation that occurred during construction can also provide insight into potential pavement problems. Periods of high rainfall could have resulted in disruption of the construction process as well as attempts to compact layer materials at excessive moisture contents.

4.3 Evaluation framework and selection of tests

4.3.1 Evaluation framework

A wide range of techniques and tools is available for the evaluation of pavements. Not all of these are always available at a reasonable cost and many are unnecessary for certain evaluations.

Table 4.1 below summarises the evaluation need for typical pavement evaluation projects as well as the appropriate tools and their availability. Many of the evaluation techniques require tools available within the department but the availability of some of the sophisticated testing equipment is limited.

Evaluation technique	When required	Tools	Availability
As-built data)	-)
Maintenance history)	-)
Historical traffic) All evaluations	-) In house
Visuals)	-)
Rutting)	Straight edge)
Deflection/curvature	All structural evaluations*	Benkelman Beam, Deflectograph, FWD	In house/limited
DCP	All structural evaluations	DCP	In house
Roughness	All evaluations (usually available from the BRMS)	Merlin, LDI, BI, HSP	In house/limited
Surface texture	Where functional aspects are evaluated	SCRIM, Griptester, Pendulum tester	In house/limited
Test pits and material testing	Where the mode of distress needs to be confirmed	Field test equipment, nuclear density meter	In house

* Judicious interpretation of deflection/curvature results is required for pavements with stabilised layers

Table 4.1 Typical pavement evaluation data requirements.

As-built, historical, visual, rutting and roughness data fulfil the minimum need. These are usually the data types in a road management system (RMS) that first identify a possible need for a more comprehensive evaluation. For post-construction audits carried out prior to the development of any distress,

Pavement evaluation can be expensive and the correct approaches and techniques must be carefully selected to optimise cost-effectiveness.

RMS data is obtained on a network level and is not normally sufficiently detailed for project level evaluations.



the investigation would need to be targeted at the specific reason for the audit. More details on the individual tools are provided in the following section.

A pavement evaluation will normally consist of an initial assessment followed by a more detailed evaluation. The process is iterative and requires more sophisticated techniques as the required degree of knowledge increases.

4.3.2 Initial assessment

The initial assessment will usually be based on an evaluation of significant changes in routine RMS survey data (e.g. visual distress, riding quality and rut depth) indicating onset of pavement deterioration. This should be complemented by a study of the as-built records and discussions with the local engineer. A drive-over visual survey is essential at this point, but for logistical and cost reasons, could be carried out by local staff. The information available at this stage should be sufficient to identify whether a more detailed evaluation is warranted.

4.3.3 Detailed assessment

The more detailed assessment will invariably include a comprehensive visual survey, rut depth measurements, a deflection survey, a Dynamic Cone Penetrometer (DCP) survey and test pitting and sampling. Laboratory testing of the samples collected will then be necessary.

4.4 Test frequency

Testing and sample collection is the most costly component of the field evaluation. It is essential to develop the pavement evaluation programme to obtain all the information necessary to carry out the rehabilitation design (or any other purpose for which the evaluation is being carried out) with the minimum amount of data collection and field and laboratory testing. A balance needs to be struck between the cost of the evaluation and the amount/quality of information required.

The pavement evaluation should include a minimum number of samples/readings per length of road as well as a minimum number per uniform section. The variability of the pavement structure and condition as well as the length of the project will normally dictate the number of sample/readings - short projects will necessarily have more observations per kilometre on average than long projects.

Numerous investigations have been carried out into the suggested minimum number of samples or observations required in pavement evaluations. This guideline includes recommendations for the various measurement techniques.

The most important consideration in undertaking field evaluations is therefore to optimise the survey needs to limit the number of separate site visits: ideally all field data should be gathered at the same time, e.g:

- deflections;
- visual data;

Structural deterioration will not always be signalled immediately from RMS survey data that is primarily related to functional performance. Significant changes in functional performance do, however, indicate possible structural deterioration.



Field testing and sampling is costly and should be carefully planned and executed.

As the number of tests increases, the cost of testing increases but the incremental improvement in the quantity and quality of information decreases rapidly (concept of diminishing returns).



DCP testing, a useful tool in pavement evaluation.



- rut depth measurements;
- DCP data, and
- any specific test pitting and materials sampling.

This assumes that any roughness data has been collected separately, usually as part of the pavement management process.

An experienced engineer/ senior technician should lead the survey team and be on site during the fieldwork to ensure that all the important data are recorded, and to instigate changes in the field sampling frequency if site conditions require.

For example, it may be evident directly from the site visit that certain sections are reasonably uniform. Since the primary objective of the field evaluation is to identify different uniform sections, and obtain sufficient data to classify them, the team leader may therefore judge that sampling frequency may be decreased where there is little to be gained from the additional sampling. Similarly, there may be sections that require more comprehensive testing for proper classification. This flexibility can ensure that the site evaluation is properly optimised to obtain the necessary data in the most cost-effective way.

The exact method of obtaining field data will depend on the field team components. One practical approach is for:

- the DCP team to also take rut measurements and record visual data;
- the deflection team (if a Benkelman beam is used) can later undertake test pitting and material sampling. This is because the deflection survey team will normally progress much faster than the DCP team.
- the team leader should generally stay with the DCP team, taking responsibility for the visual evaluation, and occasionally checking the progress of the deflection team.

Experience has shown, however, that the visual and rutting surveys are best done first as an independent exercise. The deflections can be done at a similar time and then, with this information the DCP and test pits can be located. This optimises the time spent on DCP and test pits. This is obviously the «ideal» situation, and the former method may be more practicable.

Critical to every survey is the need to tie-in the data with fixed physical features. Milestones (kilometre posts) are essential to note, as these will usually provide the main means of reference when later processing all the data. Other significant features will be:

- town boundaries;
- junctions;
- rivers/bridges, and if possible;
- culverts.

Sections in cut or on fill should also be demarcated, as these can have an influence on the pavement behaviour and condition.

Nominal frequency of testing for the various main field data parameters is suggested in Table 4.2 below. This assumes that the survey length is at least ten kilometres but, in line with the foregoing, the actual frequency selected should be adapted to suit the survey and may be varied in the field as deemed

The team leader should be experienced in pavement evaluations to enable important decisions to be made on site.



Measurements of roughness using a MERLIN apparatus.

Whenever possible the team leader should have any construction or as-built data on site, especially to identify where sections change, and to assist in the task of optimising the survey needs.



Milestones are useful features as the main means of reference.



necessary. Specific aspects related to individual evaluation techniques are discussed in subsequent sections where relevant.

Measurement type	Frequency	Comment
Deflection (Benkelman beam, Falling Weight Deflectometer)	100 metres	This is normally sufficient. For areas of localised distress, more frequent readings would be appropriate to better delineate the section. The Deflectograph gives a far more comprehensive survey automatically (one reading every 6 metres).
Dynamic Cone Penetrometer	500 metres	More frequent sampling may be needed if there is reason to suspect that conditions vary significantly.
Rut depth (straight edge)	50 metres	More frequent sampling may be needed if there is reason to suspect that conditions vary significantly. Rut depths should be taken at least at every point where deflections are made.
Visual evaluation	Effectively continuous	Data forms allow comprehensive recording of distress type, degree and extent. Photographs should be used sparingly but effectively to supplement the visual survey.
Test pits and material sampling	2 or 3 per 10 kilometres	Location and need should be identified during the field survey. Dependent on number of uniform sections.

Table 4.2 Suggested minimum testing and sampling frequencies.

B

PART B EVALUATION METHODS

- 5 Visual evaluation
- 6 Rut depth measurement
- 7 Roughness
- 8 Pavement strength
- 9 Test pit profiling and sampling

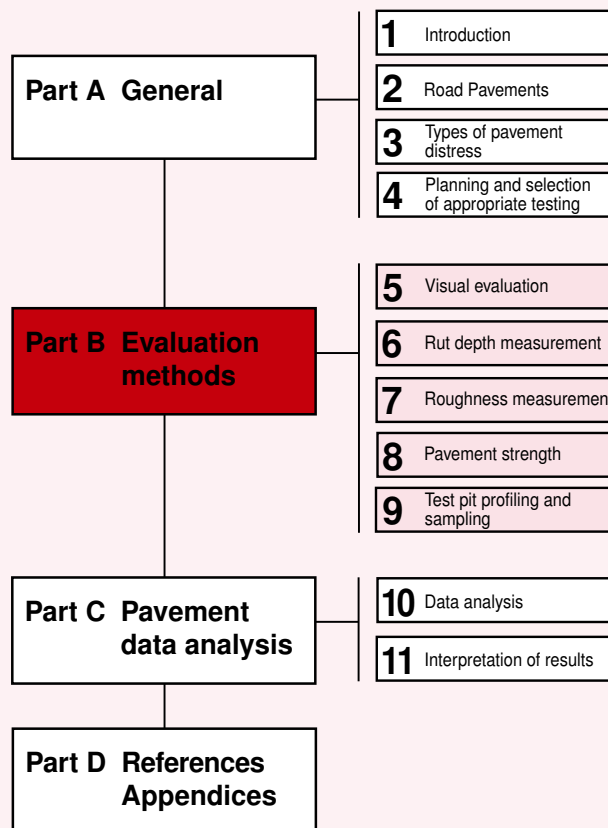



5 VISUAL EVALUATION

5.1 Methodology

The visual evaluation is one of the most important aspects of the pavement evaluation process. This usually involves a comprehensive survey of the road while a variety of parameters is visually evaluated in detail. The conventional means of collecting visual evaluation data for road management systems is from a moving vehicle (usually not exceeding 20 km/h) with periodic stops to get information that is more detailed. Visual assessment for pavement evaluation purposes, however, will normally be determined at walking pace. If budget and time constraints exist a method of representative sampling may be used. This will require a prior subdivision of the road into sections of similar visual condition.

Visual evaluation generally requires a rating of degree and extent of the various distress parameters by an experienced person or preferably a team of two or more. It is essential that all raters use a standard rating system. The raters must also be calibrated against each other periodically for consistency. Typical pavement conditions visually evaluated include:

- Cracking;
- Ravelling;
- Failures/potholing;
- Patching;
- Pumping;
- Deformation;
- Bleeding (flushing);
- Surfacing condition;
- Drainage, and
- Edge-break.

In most cases a nominal rating system can be used although, in certain instances, quantification of the various types of distress should be carried out.

It is also important that during the visual evaluation, variations in the width of the road are noted. This is necessary for costing any proposed improvements as well as being useful indicators of problems arising from inadequate width, i.e. edge breaking, shoulder problems, outer wheel path failures, etc.

5.2 Data collection

Many techniques and methods are used for visual evaluations, each being developed and adapted to the needs and methods of the evaluator and the project. In this guideline, two techniques that have been used successfully in Botswana and in other areas of southern Africa are discussed.



Visual inspection of the pavement is one of the most important aspects.



By carrying out visual inspection immediately after rainfall, pavement defects such as rutting/depressions clearly show up.

The visual assessment provides the primary means of interpreting other data parameters and identifying possible mechanisms of distress.

Methods of rating roads have been described in a number of publications of which TMH 9⁹ appears to be the most suitable for use in Botswana.



Excessive shoulder drop off.



1. *Degree and extent rating technique:* In this technique the exact location within the assessment section (usually 0.5 or 1.0 km) is not recorded, only the extent of the occurrence of the distress is summarised in an extent rating together with the representative degree (severity) rating.

This technique is usually applied to the initial assessment, which is done from a slow moving vehicle. The results are used in the initial definition of uniform sections.

2. *Degree rating on short segments:* In this technique the severity representative of the distress is recorded over a shorter length (100m or less).

The second technique is usually applied to the detailed assessment, which is done by walking. The assessment provides the actual position of distress items within an accuracy that is related to the length of the segments. However, the first technique is usually sufficient for typical pavement evaluations.

Where appropriate, consideration should also be given to the possible use of the data in HDM-3 or 4 project evaluations. The data format should then be compatible with format as described in the BRMS assessment manual.

The rating of degree and extent of the various distress parameters must be carried out by an experienced evaluator following a standard procedure. This is usually carried out per one km (initial assessment) or 100-metre section (detailed assessment) but specific localised conditions should be accurately located and measured (usually paced out or measured by measuring wheel).

It is recommended that the degree and extent of the distress modes be rated using five point scales as set out in Table 5.1.

Degree	Description
1	Distress difficult to discern visually (sound)
2	Easily discernible distress but of little consequence
3	Distress is notable with respect to possible consequences (warning)
4	Distress important with respect to possible consequences
5	Distress extreme with respect to possible consequences (severe)

Table 5.1 Degree and description of distress modes.

If no distress is present or discernible, no rating should be given.

Analysis of the pavement evaluation data for rehabilitation purposes should make use of only degrees 1, 3 and 5 (sound, warning and severe respectively). In these cases both degrees 1 and 2 would be considered as sound, degrees 3 and 4 as warning and degree 5 as severe.

The extent of the distress must also be rated. This is frequently done on a five-point scale of areal extent (20 per cent intervals) but problems are often encountered when various degrees of distress are observed within a section,

Methods of rating roads have been described in a number of publications including TMH 9, TRH 6, TRH 2, Botswana Road Management System Manual, and Overseas Road Note 18^{3,4,5,6,7}.



Degree 3 cracking.



Degree 5 cracking.

Degrees 2 and 4 should only be used when detailed pavement failure studies are being carried out.



the higher degrees being significantly less in extent than the general degree of distress. It is thus recommended that the following rating system be used for extent (Table 5.2):

Extent	Description
1	Isolated occurrence, not representative of the section being evaluated
2	Intermittent (scattered) occurrence, over parts of the section length
3	Intermittent occurrence over most of the section being evaluated or extensive occurrence over a limited portion of the section
4	Frequent occurrence over a major portion of the section
5	Extensive occurrence

Table 5.2 Description of extent of distress.

The combination of the extent and the degree should best describe the general condition of the pavement. For general rehabilitation studies, a three-point scale should be employed using isolated, scattered and extensive.

Field data collection should be carried out using standard forms to ensure that all the necessary information is collected. Examples of form that can be utilised are included in Appendix A. A summary of the descriptive definitions for each visual parameter is also included in Appendix A. A copy of this should be attached to the clipboard for field use.

5.3 Analysis and presentation

The visual evaluations can be used alone, or in combination with other evaluation parameters such as riding quality and rut depths. As the data consist of various parameters and include severity and extent, they are most easily evaluated in terms of a single parameter. A Visual or Pavement Condition Index can be developed from the data. This expresses the condition of the pavement at a point or over a designated length of road as a single value. Many methods of doing this exist and most Pavement Management Systems include algorithms for calculating an index. Many of these are highly complex involving the degrees and extent of a number of distress parameters with various weightings of their importance. The proposed approach that is widely used in southern Africa can be calculated in the visual condition data spreadsheet using the models provided in Appendix B.

If necessary, more than one combination of descriptors can be provided, e.g. degree 5/ extent 1 and degree 3/extent 5.

Reference should be made to TMH 9³ or the BRMS⁶ Raters Manual for additional detail regarding visual condition rating.



Degree 3 pumping.



Degree 5 pumping resulting in potholes.

The method described in TRH 22⁵ and used previously in Botswana is recommended.

B

6 RUT DEPTH MEASUREMENT

6.1 General

Over the years, various lengths of straight edges as well as string stretched across the road have been used for rut depth measurement. The rut depths obtained using the different techniques can vary considerably depending on the mode of rutting, wheel path width, carriageway width and general shape of the road. This aspect requires standardisation if results are to be comparable.



HSP showing rut measurement equipment at rear.

The RMS would normally include rut depth measurements of the road network determined every 2 or 3 years using a profilometer. This data should not be neglected during pavement evaluations.



A rut measurement team in action. Note the flag man for safety reasons.

It is recommended that a spare 2-metre straight edge is available during rut depth measurements in case of accidental damage to the one in use by vehicles.

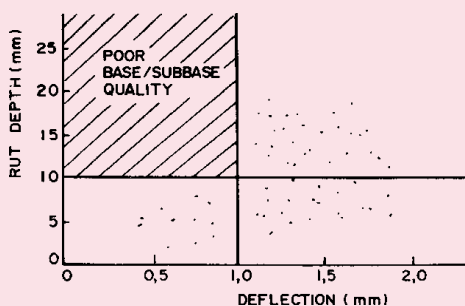

The measurement of rut depths is best carried out using a standard straight edge and a calibrated wedge. On the basis of its general use and its ease of handling and transportation, a 2-metre straight edge is the most practical.

Automated rut depth measurement devices are also available, usually towed behind or a component of some other pavement evaluation device e.g. high-speed profilometers. These usually equate with a two-metre straight edge or, in the case, of high-speed profilometers, can usually be set to equate with any desired straight edge length. It is important to specify the requirement to the service provider.

6.2 Test procedures

It is recommended that a standard 2-metre straight edge with a calibrated wedge be used for rut depth measurements. Where no 2-metre straight edge is available, it is possible that a 2-metre length of string be substituted. The string technique is not generally recommended, however, as it requires considerable practice to avoid over-reading.

Normally it is sufficient to measure the maximum rut in the outside wheel paths, which in most cases have the greater rut. On most roads, it is usually found that the heaviest trafficking occurs in one direction but ruts should nevertheless be recorded for both directions. For single carriageway two lane roads, the remedial action will be governed by the worst case, while for dual carriageways it may be possible to have different remedial actions for each carriageway.

Generally, for the delineation of uniform sections where absolute values are not essential, other methods of rut depth measurement may be used, even though there may be slight differences in actual recorded values due to the method adopted. In terms of recognised terminal conditions, the 2-metre straight edge should, however, be employed.

6.3 Test frequency

It is generally recommended that a minimum testing frequency for rut depths is every 50 metres although it may often be necessary to carry out rut depth measurements at intervals as low as 20 metres depending on the variability and the length of the expected uniform sections. It must be ensured that the number of measurements is adequate to provide a statistically acceptable value per uniform section, i.e. at least 20 readings per wheel path per uniform section.



6.4 Analysis and presentation

No specific further data processing is necessary for the rut depth measurements at this stage. However, the data from different wheel paths must be kept separate and no attempt made to combine or statistically simplify them. The cumulative sum («Cusum») approach can be used to identify preliminary uniform sections using the rut depth data (see Appendix H). Where mechanical surveys have been carried out, the 95th percentile value of the rut depth per 100 metre section can be evaluated using the “Cusum” method. Simple relationships between rut depth and other parameters, e.g. deflections, can be investigated at this stage. The relationship between the rut depth and deflection can also be used to estimate the maximum deflection that will result in a specified terminal rut depth under the past accumulated traffic (Figure 6.1) as well as overstressed subgrades. Trends where the rut depth increases with deflection (e.g. Figure 6.1) indicate that overstressing of the subgrade was probable⁸. Ideally, specific relationships should be developed for generic pavement structures in Botswana.



Shoving due to unstable base course layer.

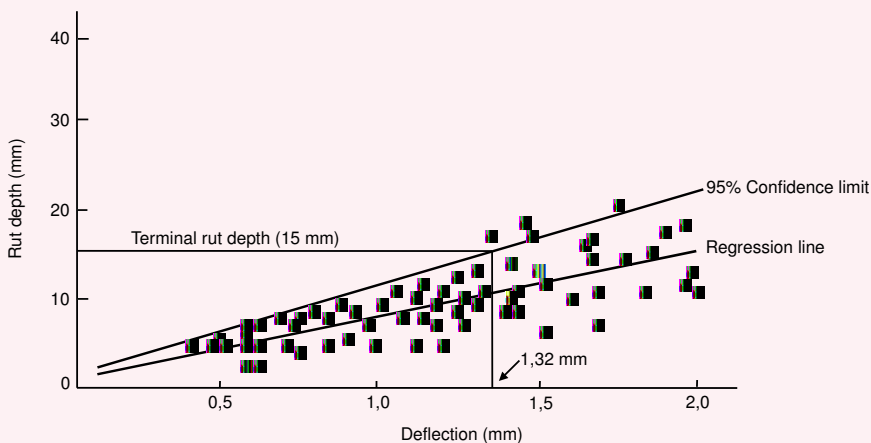

Figure 6.1 Example of relationship between deflection and rut depth.

The presence of significant rutting with the rut depth increasing with increased deflection is indicative that the pavement structure does not protect the subgrade.

7 ROUGHNESS MEASUREMENT

7.1 General

Most pavement defects contribute in some way to increasing the roughness of the road pavement, although in its early stages cracking may cause little or no change. However, without proper maintenance, the cracked surfacing deteriorates and the resulting potholes and subsequent patching will cause an increase in roughness. The roughness of roads with similar pavement construction is therefore a good measure of their relative pavement condition, but does not identify the nature of the failures or their causes.

Roughness measurements may make use of various principles.

Absolute profile – profile elevation relative to a true horizontal datum e.g., rod and level, dipstick, straight edge.

Moving datum profile – measures deviations of the profile relative to a datum moved along the road e.g. rolling straight edge, profilographs, MERLIN. The use of a rolling straight edge would not normally be recommended for pavement evaluation purposes, as the results can usually not be interpreted in terms of a standard roughness scale such as the IRI.

Vehicle motion instruments – either measure displacement between axle and body of a vehicle (e.g. Bump Integrator and Linear Displacement Integrator (LDI)) or measure accelerations of axle or vehicle body using an accelerometer e.g. Automatic Road Analyser. Details of this type of equipment are provided in Appendix C.

Dynamic profile instruments – these instruments measure elevations electronically relative to an artificial horizontal datum e.g. high-speed profilometers.

Roughness is obviously speed dependent and each of these techniques therefore has unique differences. The International Roughness Index (IRI), the most widely used parameter for roughness measurement, is a mathematical statistic of the longitudinal profile obtained from the individual outputs of the measurement techniques. Approximate comparisons of the IRI values with QI, BI and PSI are shown in Table 7.1.

Roughness measurements can be carried out using various types of equipment and apparatus, each having its own advantages and disadvantages.



HSP showing laser based riding quality measurement apparatus.



IRI	QI	BI	PSI
0	0	0	5
2	18	1369	3,5
4	46	2976	2,4
6	74	4687	1,7
8	102	6468	1,2
10	130	8305	0,8
12	158	10186	0,6
14	186	12106	
16	214	14059	
18	242	16042	
20	270	18051	

Table 7.1 Approximate comparisons between IRI, QI, BI and PSI (after Paterson, 1987¹).

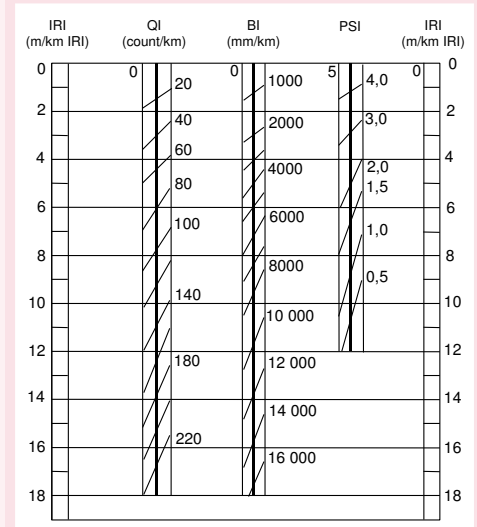

Comparison of roughness scales.

Use has been made in Botswana of various straight edges but a MERLIN⁹ and a number of Rolling Straight Edges¹⁰ have been used more frequently. High-speed profilometers are used for the RMS.

7.2 Test procedures

The most common moving vehicle roughness units used in Botswana are the International Roughness Index (IRI), the Quartercar Index (QI), Bump Integrator and the Present Serviceability Index (PSI). It is recommended that the IRI be utilised routinely as this is the measure employed in the BRMS.

The method of roughness measurement is also not usually critical if the data values can be reliably converted to IRI (now preferred as an international standard) or QI (tending to be superseded by IRI). The most important factor is for the data to be tied in with fixed physical features, especially milestones (kilometre posts), as there are likely to be differences between vehicle distance measurement readings and project road distances. Such differences will be accommodated during the first part of data processing to ensure all field data can be directly correlated based on the fixed field features.

The MERLIN should be used for routine evaluations of short pavement sections, probably less than 10 km. The time and effort required for sections longer than this probably make vehicle-mounted measurement devices more cost-effective and practical. Additional details on the use of the MERLIN are included in Appendix C.



The MERLIN apparatus, in operation.

7.3 Test frequency

The test frequency is a function of the method used. Most roughness measurement devices have fixed measurement intervals. The measurement interval for the MERLIN is based on a whole number of revolutions of the wheel such that 200 measurements are made within the test section. BI and LDI usually average the readings collected every 100, 500 or 1000 metres and this is fixed for that equipment. Essentially an averaged continuous reading is obtained for roughness measurements.

7.4 Analysis and presentation

Depending on the method of measuring the roughness, raw data may be in the spreadsheets. These data will need to be converted to IRI units using the latest calibration models for the specific vehicle or method used to obtain the data. The data can be used to determine excessive vehicle operating costs (VOC) due to high roughness, e.g. in the HDM-3 or 4 models. As for the rut depth evaluation, relationships between the road roughness and rut depth can be used as a simple indication of overstressing of the subgrade⁸. Additional information on the analysis of the roughness measurements is provided in Chapter 10.

Careful and regular calibration of any response type measuring system is essential to ensure that the IRI values calculated are repeatable and accurate.



8 PAVEMENT STRENGTH

8.1 General

The relative strength of a given pavement is inversely proportional to its deflection. Knowledge of the peak or maximum deflection in itself is insufficient, however, to determine the pavement strength, as this would depend on the specific pavement structure. In situ measurements of the actual strengths of the individual layers are necessary to quantify the pavement structure fully.

Traditional in situ strength testing has mostly been carried out with the in situ CBR test or the plate-loading test. Both of these tests are destructive in that the layer to be tested needs to be exposed. A plunger with the same dimensions as the laboratory CBR test is forced into the layer for the in situ CBR test and a circular steel plate is loaded for the plate-loading test. Both tests require vehicles or large masses as reactions (kentledge) for the applied loads and are time consuming but provide results that can be related to the design process. The CBR result is closely comparable with the laboratory CBR test result even though the grading is likely to be different (the maximum particle size in the laboratory test is 19 mm) while the plate load test provides an estimate of the elastic modulus of the layer material. It should also be noted that, unless otherwise treated, the material is tested at an in situ moisture condition that may differ considerably from the laboratory soaked CBR normally used for the pavement design. The soaked condition can dramatically influence the CBR result.

The Dynamic Cone Penetrometer (DCP) can be used to estimate an approximate CBR strength of the individual layers in a pavement structure rapidly with minimal disturbance to the pavement. In this way, many results can be obtained quickly and the statistical evaluation of these will generally provide a more representative measurement of the pavement strength than a limited number of in situ CBR or plate loading tests.

The nominal relative strength of a pavement can also be calculated in terms of the AASHTO structural number¹¹. This method uses the sum of the summed products of the thickness and strength coefficient for each layer to provide a discrete number for any pavement profile. Hodges et al¹² modified the original structural number by including a subgrade contribution, which is necessary when evaluating pavements on strong subgrades such as those commonly encountered in Botswana.

The modified structural number (SNC) is calculated as¹:

$$SNC = 0.04 \sum a_i h_i + 3.51 \log_{10} CBR - 0.85 (\log_{10} CBR)^2 - 1.43$$

Where

a_i = material and layer strength coefficients (Appendix D)

h_i = layer thickness (mm)

CBR = in situ CBR strength of subgrade (%).

Relationships have been developed between the peak deflection results obtained from FWD testing and the SN value^{13,14,15,16}.



The DCP apparatus, in operation.

Like the in situ CBR and plate load tests, the strength/modulus determined with the DCP is that at in situ moisture and density conditions and is thus not directly comparable with the soaked laboratory results that are determined at a prescribed density.

For soft subgrades the AASHTO structural number SN can be calculated using $SN = 0.04(a_1 h_1 + a_2 h_2 + a_3 h_3 + \dots + a_n h_n)$ where the layer thickness h is in mm.

Relationships similar to these will be offered as an optional method of measuring the structural number in HDM-4. Experience in Botswana has shown that strong subgrades influence the correlation between SN and deflection.

Deflection bowls can be used to calculate the stiffnesses of the various layers within a pavement. Complex back-calculation methods are necessary and the computation of E-modulus values in this way requires a good understanding of the pavement behaviour, the layer materials and thicknesses in order to avoid spurious results. The use of DCP data to assist with the estimation of values for the material stiffness and layer thicknesses is of great value.

8.2 Deflection measurements

The timing of deflection measurements is very important. Experience in Botswana has shown that the deflection in the dry season can be as low as 65 per cent of that in the wet season. Deflection measurements should therefore preferably be carried out in the wet season i.e. between March and May.

TRL have very rarely found 'traditional' fatigue cracking (i.e. initiating at the bottom of the layer) in asphalt surfacings, but rather cracking from the top.

Deflections are inversely proportional to the relative strength of a given pavement, but additional information such as radius of curvature and layer strengths is needed to quantify the structure fully.

Deflectograph and FWD equipment are not very common and the owner of the equipment would carry out this specialised testing.



Deflection beam testing.

More detail regarding calculation of deflection bowl parameters is provided in TRH 12^o.



Deflectograph.

As a loaded vehicle moves over a road, the pavement surface deflects downwards before returning to its original, or close to its original, position. This is termed the deflection and is a function of the magnitude of the load applied, the pavement structure (layer thicknesses and strengths) and the subgrade properties. The performance of bituminous surfacings is closely related to the deflection in a pavement as repeated flexing results in fatigue failure of the surfacing and the development of cracking. Not all of the deflection is recovered after each load application and, with time, this accumulates to produce permanent deformation.

Some controversy still exists about whether cracking of asphalt is generated from below or from above. Cracking from the top would explain why there is often a delay between the first appearance of cracking and development of roughness - water finally entering the pavement after the crack develops to the full depth of the asphalt layer.

8.2.1 Types of equipment

Deflection measurements with a Benkelman Beam use a standard wheel load although this varies from country to country. This equipment is usually available within most Road Departments. The Deflectograph uses a standard 80 kN axle load (40 kN dual wheel load) whilst the Falling Weight Deflectometer (FWD) can make use of variable loads.

An important component of deflection measurements is the degree of curvature of the deflection bowl. This gives an indication of the stiffness of the upper portion of the pavement structure. The radius of curvature can be determined (using the Dehlen Curvature Meter) during Benkelman Beam testing or can be calculated from deflection bowl measurements e.g. from the Deflectograph or FWD.

Deflection bowl parameters from FWD tests include Base Layer Index (BLI), Middle Layer Index (MLI) and Lower Layer Index (LLI) as shown in Appendix E, Figure E4. These give an indication of relative contributions to overall pavement strength from the surfacing and base (to 300mm depth approximately), subbase and upper selected layers (300 to 600mm depth approximately), and selected layer and subgrade (600 to 900mm depth approximately) respectively. They are obtained from the nominal deflection bowl, and can provide some guidance on where weak layers occur.

A number of instances have been observed where high peak deflections are measured but DCP and test pit information has shown no weak layers in the top 800 mm of the pavement. The inference is that weak layers occurring at depths beneath 800 mm can affect the deflection measurement significantly. This can usually be confirmed by evaluating the radius of curvature – weak layers at depth should be manifested by high radius of curvature results.



8.2.2 Test procedures

The strength of a road pavement is inversely related to its maximum vertical deflection under a known dynamic load. Deflections measured under a slowly moving wheel load, therefore, can be a good indicator of the overall strength of a pavement. These measurements are very useful in helping to identify the cause and extent of any differential performance along a road and, subsequently, for the design of any maintenance or rehabilitation measures required for different sections of the road.

The main methods of deflection measurement are:

- Benkelman Beam;
- Deflectograph, and;
- Falling Weight Deflectometer (FWD).

The first two methods determine deflections under a slow moving vehicle wheel load. The FWD gives a response to an impulse load of a falling weight. Both latter methods also provide more information regarding the shape of the deflection bowl. The absolute values obtained using each method may differ significantly. It is therefore recommended that deflection values be treated on face value, without attempting to convert to a different deflection standard, as each method will certainly allow differentiation of structurally dissimilar sections. The only proviso is that any deflection beam readings be adjusted linearly to a nominal 40kN wheel load (80kN axle load) if necessary. This processing will be done during the first stage of data validation.

Both transient and rebound deflections can be measured with the Benkelman Beam. In one case the loaded wheel moves towards the beam tip (transient) while in the other the wheel starts at the beam tip and moves away (rebound). Slightly different responses are recorded but, in practice, the rebound method is far easier and quicker to apply. Detailed information on Benkelman Beam and Falling Weight Deflectometer testing is included in Appendix E.

8.2.3 Test frequency

It is important to acquire sufficient data to yield statistically acceptable results and a minimum of 20 results per uniform section should be obtained. For long uniform sections, testing at a maximum of 100 metre intervals should be carried out. The Deflectograph has the advantage that testing is carried out on an almost continuous basis with readings taken at about 6 metre intervals.

8.2.4 Analysis and presentation

Apart from correcting the data for any discrepancies in distance measurement or wheel load, no specific further data processing is recommended for deflection measurements. If accurate data is available, moisture correction of deflection measurements can be considered. The data from different wheel paths must be kept separate and no attempt must be made to combine them.

Any deflection readings must be adjusted to a nominal 40kN wheel load, as this is regarded as a standard test load in southern Africa.



Falling Weight Deflectometer showing geophones.

It should be noted that each method gives different specific deflection values, which can be broadly correlated. However, the correlation will differ according to pavement structure, and applied loading.

Deflection testing can be either labour intensive (Benkelman Beam) or capital intensive (FWD and Deflectograph) and the cost of deflection testing is thus high. The number of tests carried out is therefore critical to the cost of the investigation.

Temperature corrections are usually not necessary for the typical pavements evaluated in Botswana, as they generally do not have thick asphalt layers (see Appendix E, Sec 3.6.1).

8.3 Dynamic Cone Penetrometer (DCP)

8.3.1 General

In most cases, the pavement strength will be determined using a DCP as this is a simple, almost non-destructive test that gives valuable information.

8.3.2 Test procedures

The normal procedures regarding use of the instrument should be followed with particular attention being paid to:

- the condition of the cone (not worn or bent);
- the device being held vertically throughout the test;
- large stones that could affect the readings;
- the hammer just touching the upper stop prior to release;
- a minimum depth of 800 mm is achieved;
- the DCP holes shall be backfilled with fine-dry sand, and the upper 50 mm of the hole shall be patched with asphalt premix.

8.3.3 Test frequency

It is recommended that at least one DCP profile is obtained in each wheel path every 500 metres. However, in order to achieve meaningful evaluation at least 20 profiles per uniform section should be obtained. As noted in Table 4.2, the actual frequency should be based on the observed condition of the pavement.

8.3.4 Analysis and presentation

The DCP data is usually evaluated in terms of CBRs of the in situ layers derived from well-established DCP/CBR correlations related to DCP penetration rates. Such derived in situ CBRs represent the in situ condition of the materials at the time of testing, and will not normally be similar to laboratory derived CBR values which are for a specific prescribed (usually regarded as worst case, i.e. soaked) test procedure. It is therefore essential to relate the field DCP results to in-situ moisture conditions at the time of testing, primarily to determine whether these are representative of typical field conditions, or of wetter or drier than normal conditions.

The standard DCP apparatus can be adapted to use disposable cones, which are left in the hole on completion of the test. These have the advantage of:

- Reducing damage to the equipment during removal after testing;
- Ensuring that the tip of the cone is always in good condition.

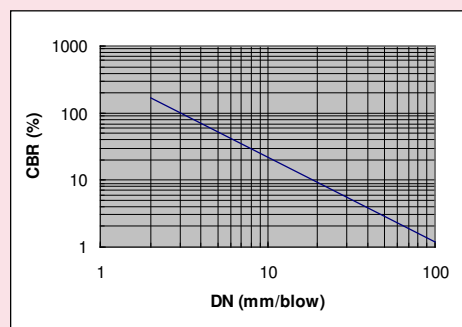

DCP-CBR correlation.

It is essential to relate the field DCP results to in-situ moisture condition at the time of testing.

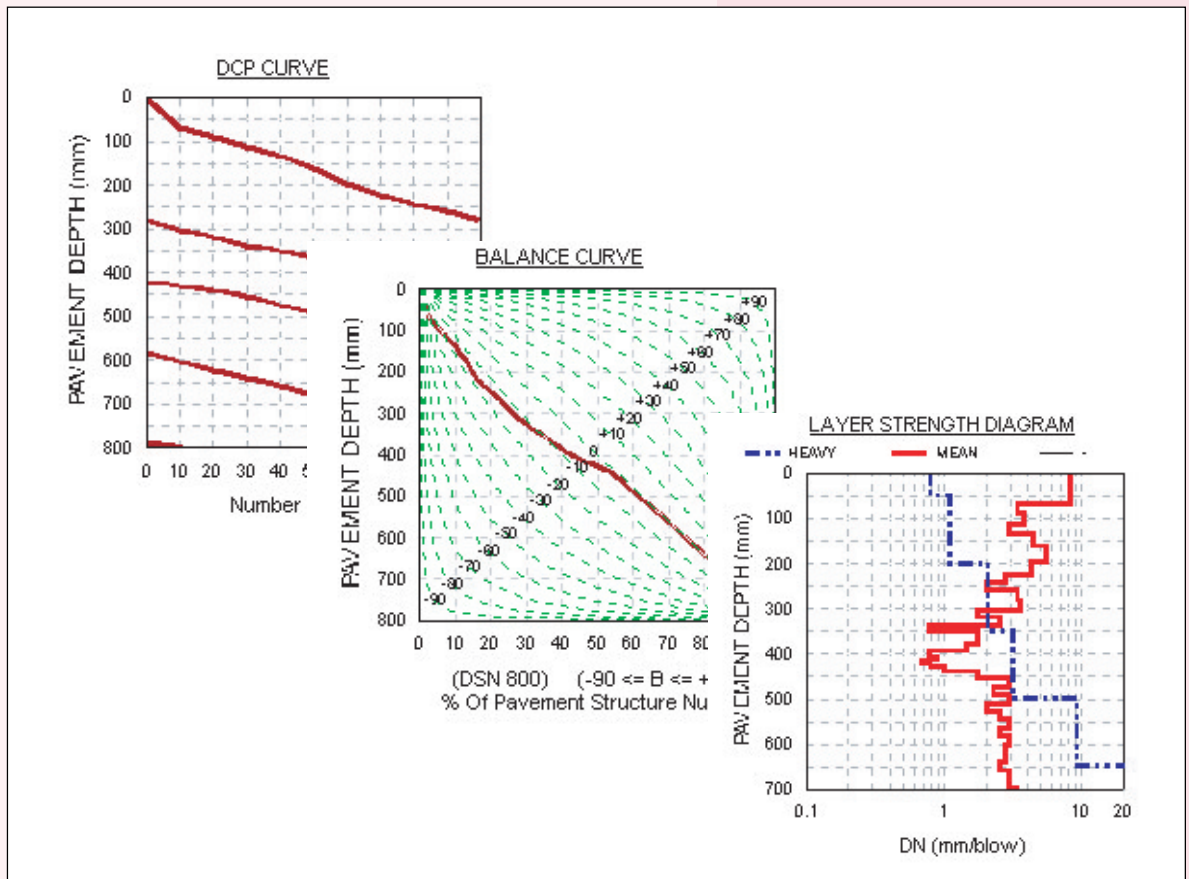

Typical examples of DCP curve, balance curve and layer strength diagram.

An important aspect of the DCP survey is the determination of the subgrade CBR as this will influence the overall performance of the pavement structure, and define the overlying layer configuration needed to provide adequate subgrade protection.

The DCP data should be plotted in terms of the penetration rate (mm/blow) through the individual layers, comparing the layer thicknesses specified in the pavement design with those identified by a significant change in the DCP penetration rate. This allows an evaluation of the construction quality (in terms of layer thickness) as well as determining an average in situ CBR strength for the constructed pavement layers.

The raw field data will normally be processed using the DCP software currently available at the Roads Department.

The derived CBR data characterising the spatial variation of the DCP profiles along the project length should also be entered into a spreadsheet. This can be used to graphically evaluate variations in layer strengths and thicknesses along the project and allow identification of uniform sections.

The new Windows version of DCP saves its files in Microsoft Access® allowing importation into Microsoft Excel®. In this way, specific relationships between the layer thicknesses and strengths can be investigated.

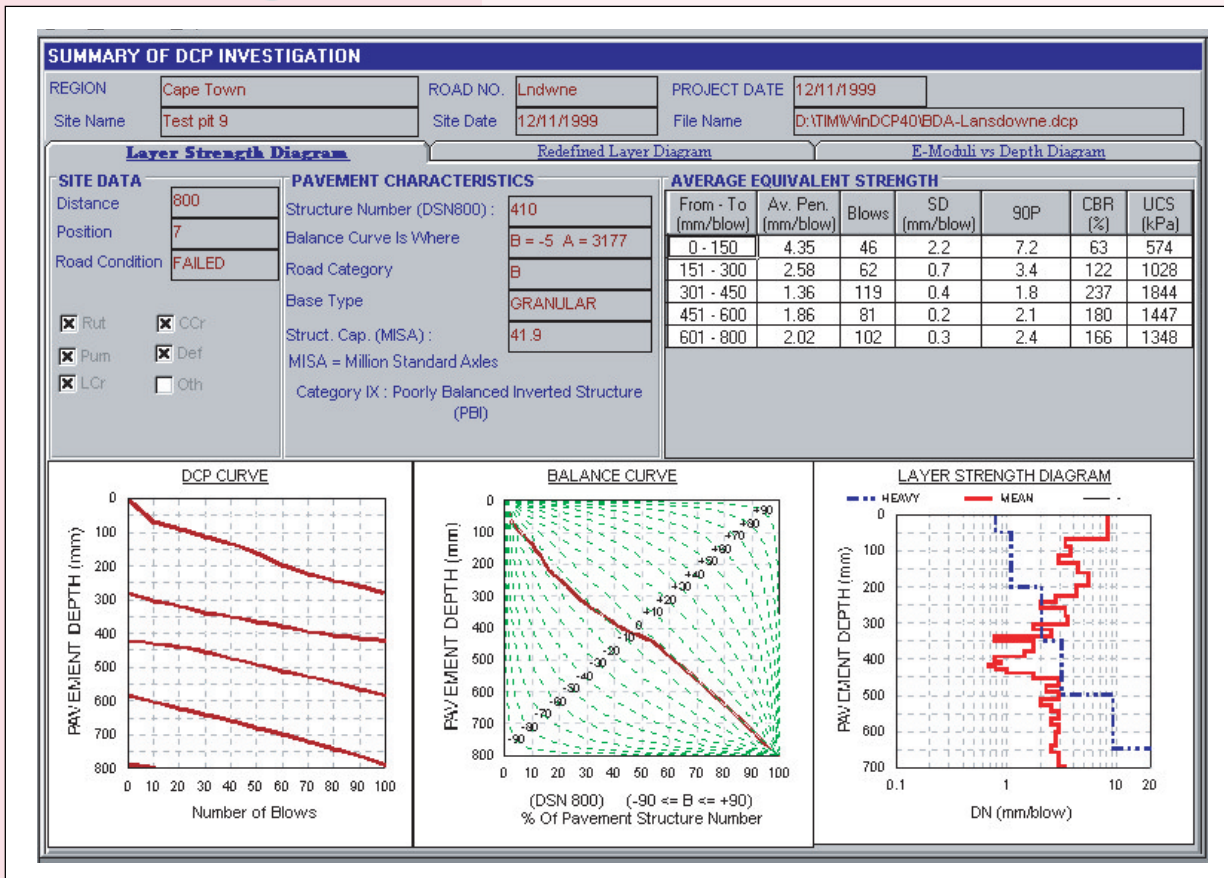

Example of Windows DCP screen output.



9 TEST PIT PROFILING AND SAMPLING

9.1 General

Only by observing the materials and layers in a road directly can exact conditions of construction be determined. The excavation of pits through the pavement with testing and sampling of the materials comprising each layer is therefore an essential part of most structural pavement evaluations.

The excavation and testing of test pits is probably the most costly part of a routine pavement evaluation. It is imperative therefore that the optimum locations are tested and that the maximum information is obtained from each test pit.

9.2 Location

The location of test pits should be carried out once sufficient information is available to divide the road into a number of preliminary uniform sections. This can be based on PMS information, rut depth surveys, deflection surveys and visual condition evaluations in association with the as-built records if available.

It is, however, important to ensure that sufficient test pits are investigated to provide adequate information regarding the nature of the pavement and subgrade materials and thicknesses of the pavement layers. It is suggested in Table 4.2 that at least 2 or 3 test pits should be excavated per 10 km. No hard and fast rules can be laid down for the test pit frequency, as it is dependent on the nature of the problem. The situation, length of uniform sections, pavement layer material use and design and mode of distress will all affect the number of test pits. Ideally, however, test pits should be located in at least:

- the visibly best, and
- the visibly worst areas of each uniform section.

This facilitates an indication of the variability of the materials, thicknesses and construction quality within the uniform section.

The locations of test pits should be determined using all the available information in order to ensure that the most valuable data is obtained.

At each location, test pits are usually excavated in the most distressed area of the road, which in most cases will be the more heavily loaded lane. The outer wheel path will be tested in nearly all cases while the inner wheel path and centre-line area are usually only investigated if the cause of any localised structural failure is being established. Test pits may also be excavated in the inner wheel path or near the centre-line, however, for audit of material properties or construction quality. Comparison of the properties of materials in the outer wheel path (trafficked under the worst prevailing conditions) and centre-line area (generally untrafficked) is particularly useful for investigating whether any material degradation has occurred under traffic.

Because of the general variability in material testing, it is recommended that all samples, trial pits, etc should be at least duplicated (or if possible triplicated

The location of the pits should be such that adequate warning is provided to traffic and the area should be cordoned off with high visibility cones. Warning signs and flagmen must also be established to provide adequate advance warning to the road user.



Typical test pit.

where time and costs permit). Triplication allows the determination of at least a mean and standard deviation for the material properties. Without these parameters, it is not possible to statistically compare whether the results come from the same population. Sampling size must be determined in accordance with the maximum size of the material e.g. British Standards give recommended minimum sample sizes. The difficulties with testing are highlighted by the likely inaccuracies associated with carrying out single in situ sand replacement density tests - usually several tests are needed to obtain a reliable mean value.

9.3 Size and depth

The areal extent of the test pit should be as small as possible so as to cause minimal disturbance of the pavement surface but large enough to:

- Permit a sample of sufficient size to be collected. A 100 mm thick layer of typical material would generally provide 180 to 200 kg of sample per square metre.
- Allow enough space to carry out in situ testing and excavation at depth.

At least one test pit at each site should be excavated to a depth at which the in situ material can be inspected and sampled. Where the road is built on a high fill:

- the top 300 mm of the fill material, and
- all the overlying layers should be
 - ✓ tested
 - ✓ sampled and
 - ✓ profiled.

9.4 In situ measurements

The investigation of test pits should follow a standard procedure.

- The surfacing should be carefully described, rut depths measured, and the general condition of the road surface, shoulders, and drainage around the site should be recorded.
- The surfacing should then be carefully removed causing minimal disturbance of the upper base course.
- Immediately on exposure of the base to the atmosphere, an in situ density determination should be carried out on the base course using either a nuclear method or sand replacement. With both methods, it is essential to obtain samples for accurate gravimetric moisture content determinations. These samples should be at least one kilogram in mass and should be oven dried to constant mass (not only for 24 hours). All dry densities should be calculated using the gravimetric moisture content and not the nuclear moisture contents.

Test pitting is a skilled operation which must be done methodically and comprehensively to gain maximum benefit. Test pits are more “traffic friendly” if excavated at an angle to the traffic direction.

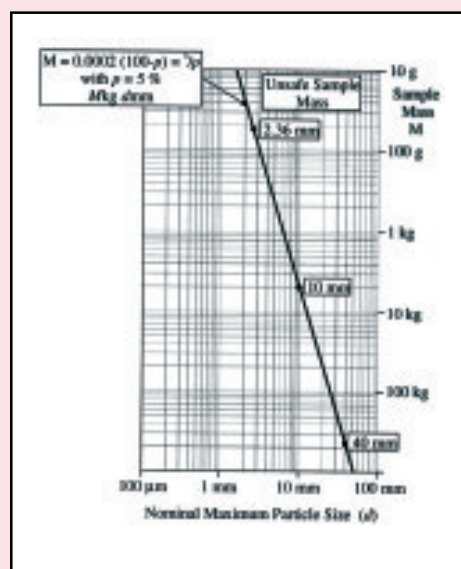

It is very difficult to carry out density tests (sand replacement or nuclear) and material profiling at subgrade level if the opening of the pit is too small.

It is recommended that a DCP test be carried out at each test pit site before opening.

All moisture samples should be placed in double plastic bags and properly sealed. Labels must be placed between the two bags using a durable labelling system. It is also good practice to write directly on the bags as well, with an indelible black marker, to minimise the possibility of confusion.



- Once the density of the base has been determined, the material should be loosened and sampled with sufficient material being collected for the laboratory testing envisaged.
- The test pit should then be carefully trimmed and cleaned until the next layer is exposed. If the materials in the two layers differ significantly, it is easy to prepare a suitable surface on the next layer for density testing. If the material comprising the underlying layer is similar to the base, difficulty is sometimes experienced in locating the top of the underlying layer. Well-defined compaction planes are, however, commonly observed.
- Each pavement layer should then be tested and sampled in turn until the subgrade is reached and this should be excavated until it is clear that the in situ material has been reached.
- Test pits should be carefully reinstated with similar quality materials to those removed and the hole sealed with cold-mix asphalt.

During sampling of test pits a summary of all samples collected with their depth and description should be made. This can be included on the soil profile description form. The samples removed from the test pits should be carefully bagged and labelled prior to submitting to the laboratory for appropriate testing. This testing usually entails grading analysis, Atterberg limits and bar linear shrinkage, compaction characteristics, strength testing (CBR), and any other testing considered necessary e.g. durability, electrical conductivity, etc.

It is often advisable to lightly stabilise (not more than 3 per cent lime or cement) the base layer during re-instatement of test pits. Adequate compaction equipment must be available to ensure sufficient compaction during re-instatement.

9.5 Description and logging of the soil profile

The seal removed from the trial pit should be closely inspected and descriptions of the bituminous surfacing (type, binder condition, adhesion to the base and to chippings, prime penetration, etc.) recorded.

Once the pit has been tested and sampled, one “wall” of it should be scraped with a spade and the pavement profile described and measured. The description should follow the standard method¹⁷. A summary sheet of the descriptions is included in Appendix F, together with a standard field data collection form. Pavements that contain any chemically stabilised layers should be sprayed with a phenolphthalein solution to determine whether any carbonation of the layer has occurred. Those areas of stabilised materials that do not react with the phenolphthalein solution (i.e. turn a dark red colour) should also be sprayed with a dilute hydrochloric acid solution and the degree of any reaction (fizzing) recorded. If possible, similar material that has not been stabilised should also be checked for the acid reaction and whether the reaction is weaker or the same as the stabilised layer. This indicates whether calcium carbonate occurs naturally in the material.



A photograph of the wall of the test pit (including a scale) can assist with recalling details regarding the pavement during later evaluation of the data. Identification of the location and details of the pit should be included in the photograph.



A photograph like this will help in recalling details, such as the crack through the base layer.



Phenolphthalein reaction in stabilised subbase.

The use of moisture prediction models provides a good indication of whether the moisture contents of the pavement layers are higher than expected and thus whether drainage problems contribute to any defects. Although the moisture within the pavement theoretically stabilises at an equilibrium value, the season during which the moisture determinations were determined should be taken into account, especially for moisture determinations in the outer wheel path areas of the road where seasonal moisture fluctuations are common.

The condition and shapes of the layer interfaces should be examined to determine where rutting and failure originates.

- Deep ruts at the surface not reflected at the base/subbase interface indicate that the rutting has taken place in the base course or asphalt surfacing.
- Where the surface rut is mirrored at the base/subbase interface or the subbase/subgrade interface, the surface rutting is a consequence of compaction or shear at a depth below the interface. Shearing within layers in the form of shiny shear planes (slickensides) can sometimes be observed in specific layers indicating problems within that layer.

9.6 Analysis and presentation

The results of laboratory and field-testing carried out must be summarised on the standard form used in the Botswana Laboratory Management System. Graphic illustrations of the pit profiles including depths and material descriptions must be provided. This can also be done using a standard spreadsheet.

Aspects such as the in situ moisture content can be evaluated in terms of expected equilibrium moisture contents (EMC) and predicted equilibrium to optimum moisture content ratios (EMC/OMC). Various models are available for the former, these being described in detail in Appendix G.



PART C PAVEMENT DATA ANALYSIS

- 10 Data analysis
- 11 Interpretation of results

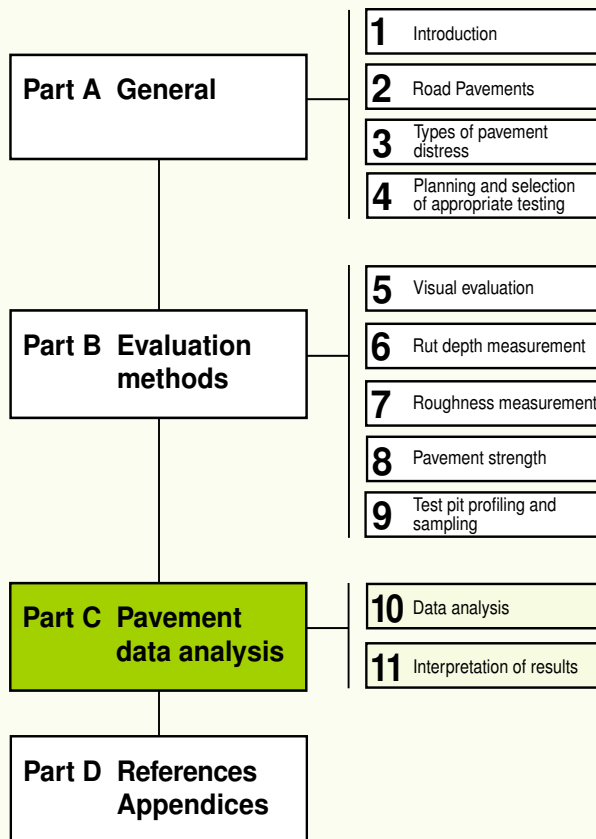



10 DATA ANALYSIS

10.1 Data analysis phases and methodologies

Mechanisms should be installed that allow pavement evaluation teams to gain the maximum benefit from the BRMS, which is an expensive project that is continually being updated and improved. The involvement of a key player in the pavement evaluation team with the BRMS is thus recommended.

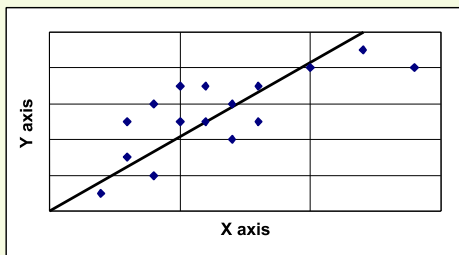

Example of X-Y plot.

As noted previously it is essential for all collected data to be referred to the actual field positions, usually in terms of the milestones (kilometre posts). This then allows direct comparison of data values and obviously means that uniform sections can be readily identified on the road.

Commercial programmes such as DOTPLOT® can be used for describing test pit profiles in a standard graphical format.

Although statistical methods can be used for data validation, inspection of the data for obvious outliers and input errors is recommended.

In carrying out pavement evaluations for rehabilitation or other purposes, it is essential that the teams involved communicate closely with each other. It frequently occurs that one team carries out the visual evaluation while field-testing, other teams carry out test pitting and sampling and the materials are submitted to the laboratory where a different team does the testing. The results are then collated by someone who may not have been involved with any of the field or laboratory work and then presented to the rehabilitation design engineer who, up to this stage, has had very little involvement with the project. It is essential that an engineer or team be appointed to co-ordinate and follow the total process and provide sufficient continuity to ensure that all components of the evaluation are used to maximum benefit.

Once all the field and laboratory data have been gathered, they should be compiled into a format that the rehabilitation design engineer can use with both confidence and minimal referral to the pavement evaluators. The data should be verified, validated and then presented in the required or a standard format.

Graphical representation of the data is the fundamental basis by which uniform sections can be identified and classified. It also allows initial data validation by clearly showing if there are outliers in the data sets that should be removed. The approach recommended is the use of spreadsheets for data processing, whereby all available raw data values are firstly entered against lineal position. This gives the basis for X-Y plotting and data review.

Data such as test pit profiles should be prepared to indicate the uniformity of pavement structures in terms of layer thicknesses and material descriptions.

10.2 Chainage adjustment

It is essential that all data presented be validated to ensure that:

- the information is correct;
- laboratory test results are correctly calculated, and
- all the information available is presented.

This is carried out during preparation of spreadsheets of all the data collected.

In line with the foregoing, the first part of data analysis is to make any necessary adjustments to the reported position data (the X-axis values) to tie in with milestones or other known fixed features. For data collected at specific points along the road (typically DCPs, Benkelman Beam or FWD deflections, rut measurements and test pits), there should be no real need for such adjustment, as the positions ought to be recorded reasonably accurately relative to the milestones.

Main adjustments will normally be needed for data collected continuously, and initially referred to vehicle odometer readings (typically roughness



measurements and Deflectograph deflections). Often the start (or end) of the project is taken as the zero reading. The process is straightforward, arising from the fact that the measured distances for the collected data are unlikely to be exactly 1 000 metres between the milestones (kilometre posts). The kilometre post positioning is assumed to be fixed at 1 000 m intervals, regardless if this is true or not. The field recorded distances between kilometre posts are uniformly adjusted to 1 000 metres (or acceptable accuracy).

The ideal case is where kilometre posts are accurate and any odometer measurement differences are consistent, because the whole data set can then be adjusted by the same factor. An example for a short section is shown in Table 10.1. It should be noted that the actual process is greatly streamlined in the spreadsheet data manipulation, and the main data check is the comparison of the adjusted chainage with the fixed reference (columns (V) and (II)).

(I) Recorded stationing	(II) Fixed reference chainage	(III) Initial comparison Start + (I)		(IV) Adjusted recorded stationing	(V) Adjusted chainage Start + (IV)	Comment on comparison of fixed and adjusted chainage values
0	36 + 65	36 + 65		0	36 + 65	Section start
0,35	37	37 + 000	✓	0,35	37 + 000	No change
1,4	38	38 + 050	✗	1.370	38 + 020	+ 20 metre, OK
2,4	39	39 + 050	✗	2.341	38 + 991	- 9 metre, OK
3,45	40	40 + 100	✗	3.360	40 + 010	+ 10 metre, OK
4,5	41	41 + 150	✗	4.380	41 + 030	+ 30 metre, OK
4,83	41 + 35	41 + 480	✗	4.700	41 + 35	Section end
Total 4,83 km adjustment needed between 0,35 and 4,83 i.e., over 4,48 km	Total 4.700 km Adjustment needed from km 37 to 41,35, i.e. over 4,35 km			Proportioned by 4,35/4,48 from station 0,35/km 37		Correlation satisfactory - all recorded station values adjusted by simple pro- portioning

Table 10.1 Chainage adjustment example.

An initial comparison is made to see whether the recorded stationing can be used without adjustment (column (III)). In this case, the comparison at km 37 is fine, but thereafter the difference is unsatisfactory and the recorded stationing needs adjustment. In this example, a simple linear proportioning is used based on recorded and actual distances. Where the difference is still unacceptable after this process, say more than 30 metres, individual proportioning over shorter fixed distances can be undertaken in the same manner. All intermediate positions (indicated by ✗ in the table) will be adjusted by the selected proportioning applicable to the specific range.

Once the adjustments are completed to give a satisfactory accuracy, the revised chainage positions are used as the x-axis for subsequent graphical review of the data. Each data set should firstly be viewed for the whole length to highlight anomalous data values and any outliers evaluated and if necessary removed from the data set (with justification).



Accurate markings on the road surface can be used as semi-permanent reference points for evaluation purposes and for subsequent rehabilitation design and cost estimation.

It should be noted that this method is an expedient to preliminary data evaluation. It allows ready field identification of sections in relation to fixed features, while acknowledging that different vehicles used will usually vary slightly in distance measurement. Errors in chainages of marker posts will be retained by this method. The method proposed above is considered the most cost-effective for typical pavement evaluations, but it would be better to have the site correctly marked out first, using an accurate odometer (and/or surveyors).

Accurate marking is essential for subsequent rehabilitation design and cost estimation.

10.3 Identification of uniform sections

When considering rehabilitation and/or reconstruction strategies, the road length must be delineated into uniform sections, based on a number of factors influencing the pavement performance. Generally, these factors include:

- Pavement type;
- Construction history (incl. rehabilitation & maintenance measures);
- Pavement cross-section (materials, thicknesses, drainage);
- Traffic; and Pavement condition.

Ideally, an historic pavement database should incorporate all these factors.

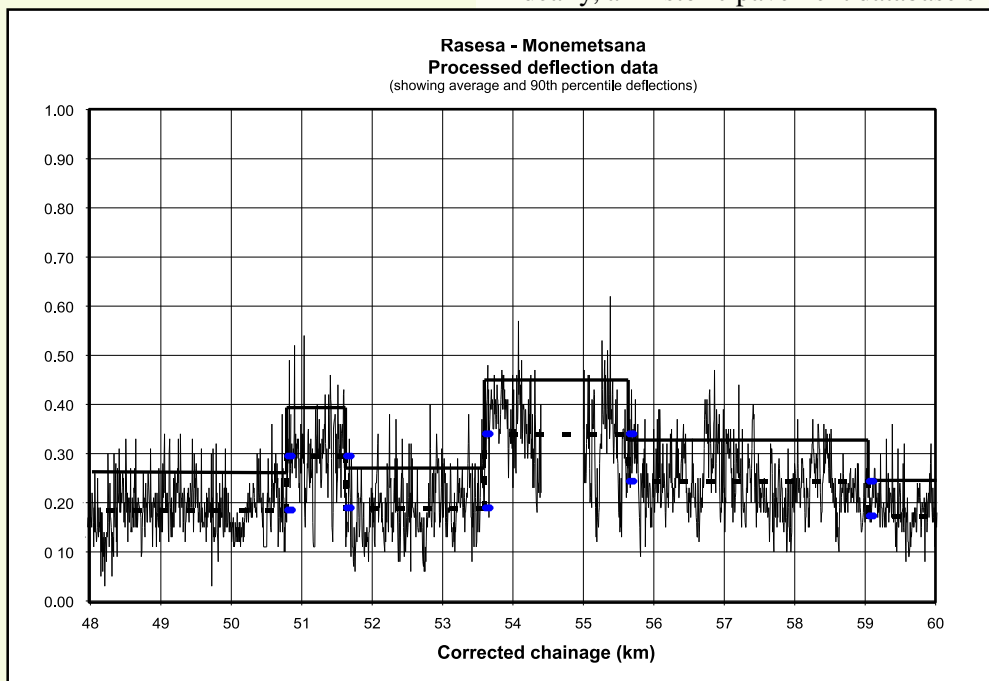

Example of uniform sectioning based on deflection data.



The as-built approach for delineating uniform sections consists of isolating each already known factor and identifying all significant changes per factor, along the road length. The road is subsequently divided in a number of sections characterised by a unique combination of factors (see Figure 10.1).

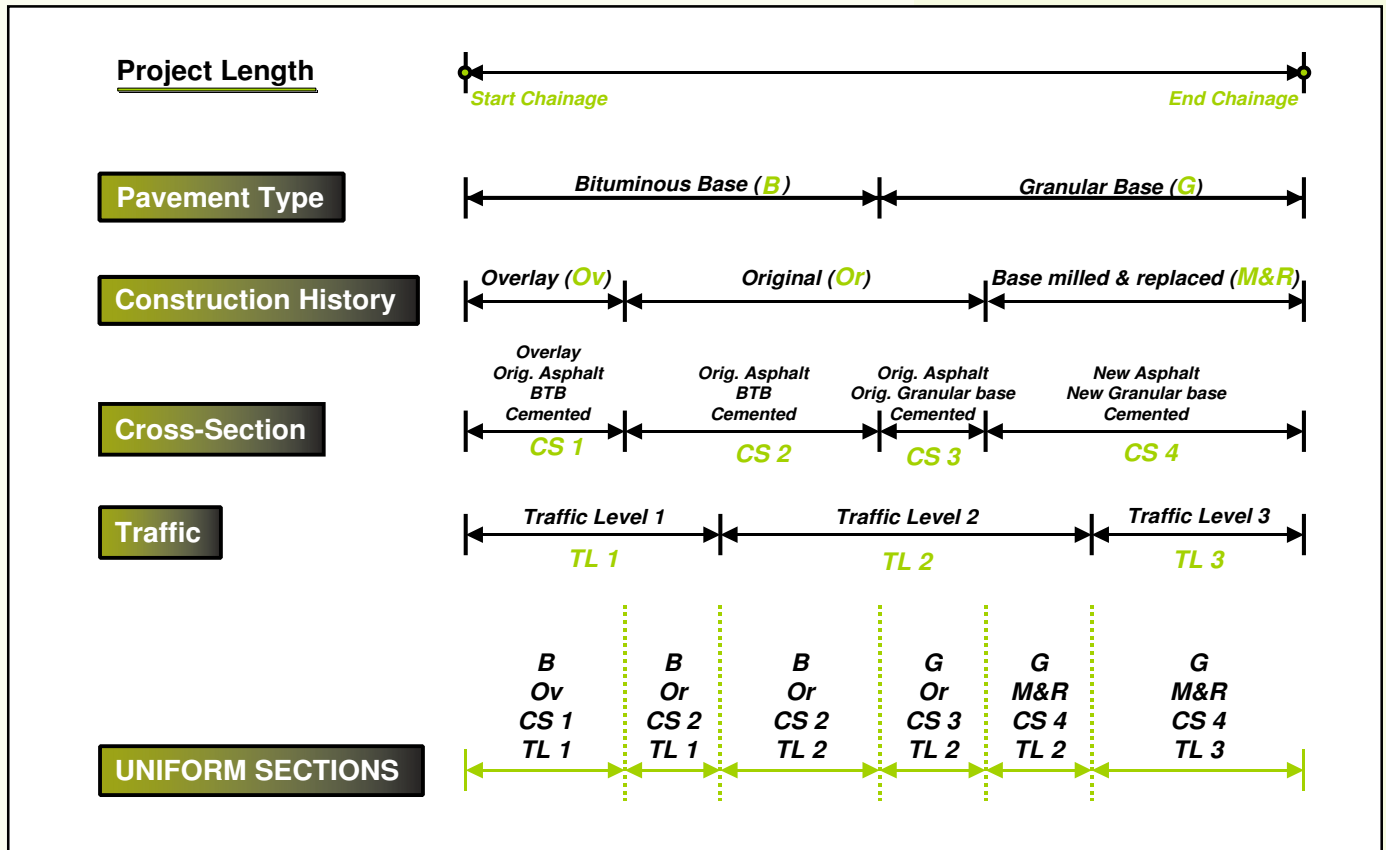

Figure 10.1 Delineation of sections using as-built approach.

Pavement monitoring activities discussed in this document measure the quality and quantity of the pavement condition. These include deflections, rut depths, visual condition, riding quality, pavement strengths, etc, and are most frequently used for delineating uniform sections. As overlaps and disagreements between the different parameters may confound the breakdown into uniform sections, it is recommended that the parameters are prioritised with:

- peak deflection being the first choice, followed by;
- radius of curvature (when available);
- rutting;
- riding quality;
- visual condition index, and finally
- DSN.

The analytical approach consists, mostly, of plots of the measured pavement condition parameter as a function of the distance along the project. Once the plot has been generated, it can be used to delineate uniform sections through several methods. A visual and, therefore, subjective examination of the plot represents the simplest, primary method.



Statistical approaches generally involve the processing of pavement condition data irrespective of their positions along the project. Such approaches normally apply to widely scattered data, and require in-depth statistical knowledge and advanced software. These techniques are considered unnecessarily cumbersome.

A 90th percentile is generally recommended and implies that 10 per cent of the road is in a worse state with respect to that parameter which for most practical purposes is in line with the natural variability of typical engineering parameters.

In addition, several mathematically defined methods can be used for optimising the findings. For example, the "cumulative difference" method as described in the AASHTO manual relies on the concept of area under a curve. The simpler cumulative sum ("Cusum") technique is recommended. The method is only useful when the data has been sampled continuously at regular intervals along the project length.

In the Cusum technique, plots of the cumulative sums of deviations from the mean parameter value against chainage can be used to differentiate homogeneous sections. The Cusum is calculated in the following way:

$$S_i = x_i - x_m + S_{i-1}$$

where

x_i = Parameter value at chainage i

x_m = Mean parameter value

S_i = Cumulative sum of the deviations from the mean parameter value at chainage i

S_{i-1} = Cumulated sum at the previous chainage i.e. chainage (i-1)

Using the cumulative sums, the extent to which the measured parameter on the different sections of road varies from the mean parameter value of the entire surveyed length can be determined. Changes in the slope of the line connecting the plotted cumulative sums will indicate boundaries between homogeneous sections.

The Cusum calculation technique is included in a spreadsheet (Appendix H).

10.4 Data evaluation

The data should be classified individually for each uniform section in order to define the representative characteristics of each section. The application of simple statistics is generally appropriate. Mean values, maxima, minima, and various percentiles of the condition parameters have been used in the past. It is recommended, however, that the 90th percentile be generally used. A different percentile value may be used if considered necessary by the design engineer e.g. where light traffic conditions prevail or where axle loads are closely controlled. The application of these simple statistical parameters assumes that the data complies reasonably closely with a normal distribution.



11 INTERPRETATION OF RESULTS

11.1 Simple methods of data evaluation

An holistic evaluation of all the data obtained from the pavement evaluation will identify the uniform sections within the project. The data should then be compiled into a table in which the selected percentile values of relevant parameters are tabulated by uniform section. The relevant parameters include those directly pertaining to the structural condition of the pavement and include deflection data, rut depths, riding quality, Visual Condition Index and layer strengths. An example of an Excel spreadsheet for this purpose is provided in Appendix I.

Once the data is tabulated, it is possible to highlight those parameters that characterise the individual uniform sections. By referring to the visual survey data, the test results and the test pit profiles, the reasons for any deficiencies in the uniform sections can be determined. Aspects such as layer thicknesses, material quality, construction quality (particularly compaction), prevailing moisture contents, etc, need to be specifically evaluated.

It is useful to plot all of the field survey data on a summary sheet showing the visual, manual and mechanical survey results with indications of the condition rating (Appendix I).

11.2 Parameters obtained from analyses

Once the parameters have been tabulated, relevant ones can be compared with standard criteria for defining the need for any improvement or upgrading. These criteria represent the boundaries between sound and warning (X), and warning and severe (Y) conditions and are summarised in Table 11.1. Road categories used in Botswana are shown as Category I and II. These are equivalent to major rural roads and lightly trafficked roads respectively.

During data analysis, past experience should be utilised. Practical experience often shows that rut-ting and isolated shear failures frequently occur and proliferate much quicker than theoretical analysis indicates.





Parameter	Base course material	Category of road			
		Category I		Category II	
		X	Y	X	Y
Deflection (mm)* (Benkelman beam)	Gravel/untreated subbase	0,5	1,0	0,7	1,4
	Gravel/treated subbase	0,4	0,9	0,6	1,3
	Lightly cemented	0,4	0,8	0,6	1,2
	Bituminous	0,3	0,7	0,5	1,0
	Cemented	0,3	0,6	0,4	0,8
Radius of curvature (m)* (Dehler Curvature Meter)	Gravel/untreated subbase	80	45	60	30
	Gravel/treated subbase	110	60	80	40
	Lightly cemented	150	75	100	50
	Bituminous	200	90	130	65
	Cemented	200	100	150	80
DCP* (DSN ₈₀₀ or number of blows to penetrate 800 mm)	All basecourse materials: assumed that readings are taken at equilibrium moisture content	230	110	155	70
Rut depth (mm)*		10	20	15	25
Riding quality (IRI)*		3,5	4,2	4,2	5,1
Cracking (%)** - Crocodile - Longitudinal		10	20	15	25
		45	75	60	90

* Usually the 90th percentile values.

** As a percentage of length of the section being evaluated.

Table 11.1 Ranges of warning values for data interpretation.

11.3 Estimation of remaining life

The data presented to the engineer will allow an estimate of the remaining life of each of the uniform sections. Various techniques are available for this and four of them are commonly used. The different methods invariably give a range of results.

South African Mechanistic Design Method (SAMDM): This method requires sophisticated computer modelling of the stresses and strains developed in the pavement structure. In order to carry out these analyses, knowledge of the moduli of the materials, the layer thicknesses and Poisson's ratio of each layer is necessary. This is usually obtained from back-analysis of deflection bowl parameters. An approximation of the material moduli can be obtained from the DCP analysis. The stresses and strains calculated are then related through various transfer functions to the carrying capacity of the pavement.

DCP method: This makes use of a comparison of the pavement structure in terms of the computer generated redefined layer strength diagram with an equivalency line developed from the predicted future traffic and the moisture regime. It should be noted that this is only reliable for a well-balanced pavement structure.

AASHTO method: An estimate of the residual life of the pavement can be calculated using the AASHTO structural number method. This requires inputs of the subgrade modulus, the AASHTO structural number, the expected change in riding quality and various reliability functions. This method is known to be conservative in terms of its pavement thickness and is thus equally conservative in terms of the estimated remaining life.

Methods for estimating remaining pavement life are discussed in some detail in the SATCC Code of Practice for Pavement Rehabilitation¹⁸ and TRH 12⁸ and additional reference should be made to these.

A well-balanced pavement is one that shows a progressive decrease in stiffness with depth. No excessively strong or weak layers cause deviation from a smooth DCP curve in the upper 800 mm of the profile.



Asphalt Institute method: This relates the maximum annual deflection directly to the structural capacity of the pavement. By subtracting the known previous traffic, the remaining life can be estimated. The method is empirically based and is valid for traffic up to about 7 million standard axles. It does allow, however, for higher traffic counts by use of the pavement component analysis procedure.

Other techniques such as the HDM-3 relationship between rutting and standard axles can be used but are often based on limited data and appear to be excessively general. The data used is often from a localised evaluation with material and climatic conditions dissimilar to those in Botswana and would thus require calibration for local use.

11.4 Sensitivity analyses

The structural analysis and remaining life estimate techniques for pavements include many assumptions. The standard assumptions that the materials are isotropic, uniform and elastic are known to be false for road construction materials. Methods of overcoming this problem are being actively researched but in the mean time, traditional analyses are utilised.

It is recommended that pavement analyses and rehabilitation designs should be based on a number of methods using a range of appropriate parameter values. The parameter values should reflect conditions that are expected to apply to seasons other than that during which field-testing was carried out (particularly if field work was carried out in a dry season). The reliability of parameters such as traffic and E-moduli should also be considered. Comparison of the various outputs will allow the selection of rehabilitation design parameters with a greater degree of confidence.

Sensitivity analyses are carried out to investigate the effect of changes in the input variables on the outcome. They are particularly useful where confidence in the accuracy of the input parameters is poor as they can highlight critical and less critical parameters.

D

PART D REFERENCES AND APPENDICES

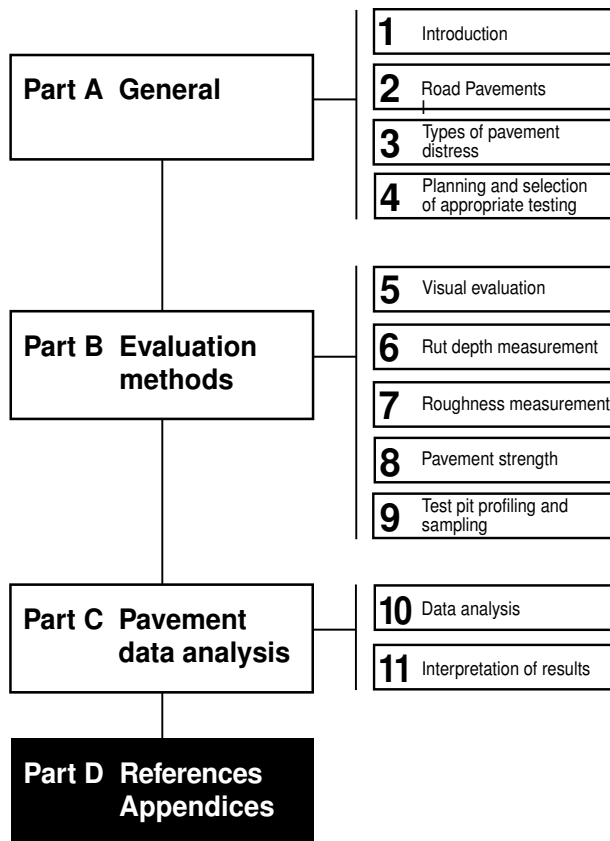

REFERENCES

1. **Paterson, W D O. 1987.** Road deterioration and maintenance effects: models for planning and management. Johns Hopkins University Press, Baltimore.
2. **Emery, S J. 1992.** The prediction of moisture content in untreated pavement layers and an application to design in southern Africa. CSIR Research Report 644 (Bulletin 20), Division of Roads and Transport Technology, CSIR, Pretoria.
3. **Committee of State Road Authorities (CSRA). 1992.** Pavement Management Systems: standard visual assessment manual for flexible pavements. Technical Methods for Highways (TMH) 9, CSRA, Pretoria.
4. **Committee of State Road Authorities (CSRA). 1985.** Nomenclature and methods for describing the condition of asphalt pavements. Technical Recommendations for Highways (TRH) 6, CSRA, Pretoria.
5. **Committee of State Road Authorities (CSRA). 1994.** Pavement Management Systems. Technical Recommendations for Highways (TRH) 22, CSRA, Pretoria.
6. **Raters manual for the visual assessment of paved roads. 1994/96.** Prepared by TTCS/VWL, Botswana.(Botswana Road Management System Manual).
7. **Transport and Road Research Laboratory, 1999.** A guide to the pavement evaluation and maintenance of bitumen-surfaced roads in tropical and sub-tropical countries. Overseas Road Note 18. Transport Research Laboratory, Crowthorne.
8. **Committee of Land Transport Officials (COLTO). 1997.** Flexible pavement rehabilitation investigation and design. Technical Recommendations for Highways (TRH) 12, COLTO, Pretoria.
9. **Cundill, M A. 1991.** MERLIN – A low cost machine for measuring road roughness in developing countries. Transportation Research Record, 1291, National Research Council, Washington, D.C., pp 106-112.
10. **Young, J C. 1977.** Calibration, maintenance and use of the Rolling Straight-edge. Supplementary Report 290, Transport and Road Research Laboratory, Crowthorne.
11. **American Association of State Highway and Transportation Officials (AASHTO). 1986.** AASHTO guide for design of pavement structures. AASHTO, Washington, D.C.
12. **Hodges, J W, Rolt, J and Jones, T E. 1975.** The Kenya Road Transport Cost Study: Research on road deterioration. Laboratory Report 673, Transport and Road Research Laboratory, Crowthorne, England.
13. **American Association of State Highway and Transportation Officials (AASHTO). 1993.** Design of pavement structures, AASHTO, Washington DC.
14. **Jameson, G W. 1993.** Development of procedures to predict structural number and subgrade strength from falling weight deflectometer deflections.
15. **Rohde, G T, 1994.** Determining pavement structural number from FWD testing. Transportation Research Record 1448, Transportation Research Board, Washington DC.
16. **Roberts, J D and Martin, T C. 1996.** Recommendations for monitoring pavement performance. Research Report ARR 293. ARRB Transport Research Ltd, Victoria.
17. **Jennings, JE, Brink, ABA, and Williams, AAB. 1973.** Revised guide to soil profiling for civil engineering purposes in southern Africa. The Civil Engineer in South Africa, January 1973, pp 3-12.
18. **Southern Africa Transportation Communications Commission (SATCC). 1998.** SATCC Code of Practice for pavement rehabilitation (Draft). SATCC, Maputo, Mocambique.
19. **Transport and Road Research Laboratory, 1985.** Maintenance techniques for district engineers. Overseas Road Note 2, Transport Research Laboratory, Crowthorne.
20. **Smith, H R and Jones, C R. 1980.** Measurement of pavement deflections in tropical and sub-tropical climates. TRRL Report LR 935. Transport Research Laboratory, Crowthorne.
21. **Jones, C R and H R Smith, 1980.** Deflection temperature relationships for bituminous surfacings in Kenya. TRRL Report LR 936. Transport Research Laboratory, Crowthorne.

APPENDICES

	page
Appendix A Visual evaluation forms and description.....	65
Appendix B Visual Condition Index (VCI).....	67
Appendix C Roughness measurement.....	68
Appendix D Pavement layer strength coefficients for structural number after Paterson, 1985).....	74
Appendix E Deflection measurement.....	75
Appendix F Test pit profiles.....	83
Appendix G Equilibrium and predicted moisture content.....	86
Appendix H Cumulative sum method for identifying uniform sections.....	87
Appendix I Pavement condition rating form.....	95
Appendix J Definition of terms.....	96

BOTSWANA ROADS DEPARTMENT

Visual Evaluation Descriptors

Degree of distress	Mode of distress										
	Bleeding	Raveling		Cracking	Deformation	Pumping	Potholes/patching	Edge break	Deep off	Drainage	
		Slurry seal	Stone seal								Asphalt
1 Sound	Stones well proud of binder. Slightly rich in binder.	Loss of individual aggregate just visible	Loss of individual aggregate just visible	Very little loss of stone or precasted chips	Faint cracks	Difficult to see < 5 mm	Fairly visible on close inspection	Not defined	Slight about 50 mm	Slight < 50 mm	Minor ponding on road surface
3 Warning	Smooth texture but stones visible in binder.	Distinct loss of aggregate in small areas	Distinct loss of aggregate in small areas	Distinct disintegration of asphalt in small areas	Open cracks < 3 mm	Discernible 10 - 15 mm	Clearly visible Minimal deformation.	Potholes > 200 mm diameter and > 25 mm deep. Patching cracked and deformed	Significant about 150 mm	Significant 50-75 mm	Surface ponding Ponding in side-drains
5 Severe	Film of binder covers all stones.	General loss of stone	General loss of stone	General disintegration of asphalt	Open cracks > 3 mm	Dangerous > 30 mm	Extensive deposits of fines - severe deformation	Potholes > 300 mm diameter and > 50 mm deep. Patching breaking up and badly deformed.	Severe > 300 mm	Severe > 75 mm	Severe ponding on surface, shoulders and in side-drains

Appendix B Visual Condition Index (VCI)

Equation B.1

$$VCI_p = 100 \left\{ 1 - C * \left(\sum_{n=1}^N F_n \right) \right\}$$

where

VCI_p = Preliminary VCI

$F_n = D_n * E_n * W_n$

n = visual assessment item number (Table B.1)

D_n = degree rating of defect n
Range: 0 – 4 for functional defects
0 – 5 for other defects

E_n = Extent rating of defect n
Range: Default 3 for functional defects
0 – 5 for other defects

W_n = weight for defect n (Table B.1)

Equation B.2

$$C = 1 / \left(\sum_{n=1}^N F_n (\max) \right)$$

$F_n(\max) = F_n$ with degree and extent ratings set at maximum. Where two or more options are available per distress, e.g. aggregate loss, use the average W_n for the calculation of $F_n(\max)$.

Equation B.3 is applied to transform VCI_p to a standard percentage scale.

Equation B.3

$$VCI = (a * VCI_p + b * VCI_p^2)$$

where

$a = 0.02509$

$b = 0.0007$

and $0 < VCI < 100$

Item No.	Assessment items	Weight (W_n)
1	Surfacing failures	6,5
2	Surfacing cracks	5,0
3	Aggregate loss	3,0
4	Dry/brittle	3,0
5	Bleeding	3,0
6	Map/Crocodile cracks	10,0
7	Block cracks	6,5
8	Longitudinal cracks	4,5
9	Transverse cracks	4,5
10	Pumping	10,0
11	Rutting	8,0
12	Deformation	4,0
13	Patching	8,0
14	Failures/potholes	15,0
15	Edge breaking	3,5
16	Riding quality	5,5
17	Skid resistance	3,0
18	Surface drainage	3,0
19	Unpaved shoulders	3,5

Table B.1 Proposed weightings for VCI calculation (modified after TRH 22⁵).

Appendix C Roughness measurement

C1 INTRODUCTION

The standard measure of road roughness is the International Roughness Index (IRI). This was developed during 'The International Road Roughness Experiment' in Brazil. It is a mathematical quarter car simulation of the motion of a vehicle at a speed of 80 kph over the measured profile and can be calculated directly from road levels measured at frequent intervals. Devices for measuring levels are usually either slow and labour intensive or fast, automatic and expensive. Hence, the roughness of the road is usually measured using a Response Type Road Roughness Measuring System (RTRRMS) that must be periodically calibrated to allow the values of roughness to be reported in terms of IRI. Methods of calibration include a rod and level survey or a standard instrument, such as the TRL Profile Beam, the MERLIN (Machine for Evaluating Roughness using Low-cost Instrumentation), the Face Dipstick and the ARRB Walking Profiler.

C2 OPERATION OF THE MERLIN

The MERLIN is available in Botswana and is thus discussed in detail below.

A diagram of the equipment is shown in Figure C.1. It has two feet, 1.8 metres apart which rest on the road surface along the wheel path. A moveable probe is placed on the road surface mid-way between the two feet and measures the vertical distance, 'y', between the road surface under the probe and the centre point of an imaginary line joining the two feet.

The result is recorded on a data chart mounted on the machine. By recording measurements along the wheel path, a histogram of 'y' can be built up on the chart. The width of this histogram can then be used to determine the IRI.

To determine the IRI, 200 measurements are usually made at regular intervals. For each measurement, the position of the pointer on the chart, shown in Figure C.2, is marked by a cross in the box in line with the pointer and, to keep a count of the total number of measurements made, a cross is also put in the 'tally box' on the chart. When the 200 measurements have been made the position mid-way between the 10th and 11th crosses, counting in from one end of the distribution is marked on the chart. The procedure is repeated for the other end of the distribution. The spacing between the two marks, D, is then measured in millimetres.

For earth, gravel, surfaced dressed and asphaltic concrete roads, the IRI can be determined using the following equation.

$$IRI = 0.593 + 0.0471 D$$

This equation assumes that the MERLIN has a mechanical amplification factor of 10. In practice this may not be true because of small errors in manufacturing. Therefore, before the MERLIN is used the amplification has to be checked and the value of D corrected. To do this the instrument is rested with the probe on a smooth surface and the position of the pointer carefully marked on the chart. The probe is then raised and a calibration block approximately 6mm thick placed under the probe. The new position of the pointer is marked. If the distance

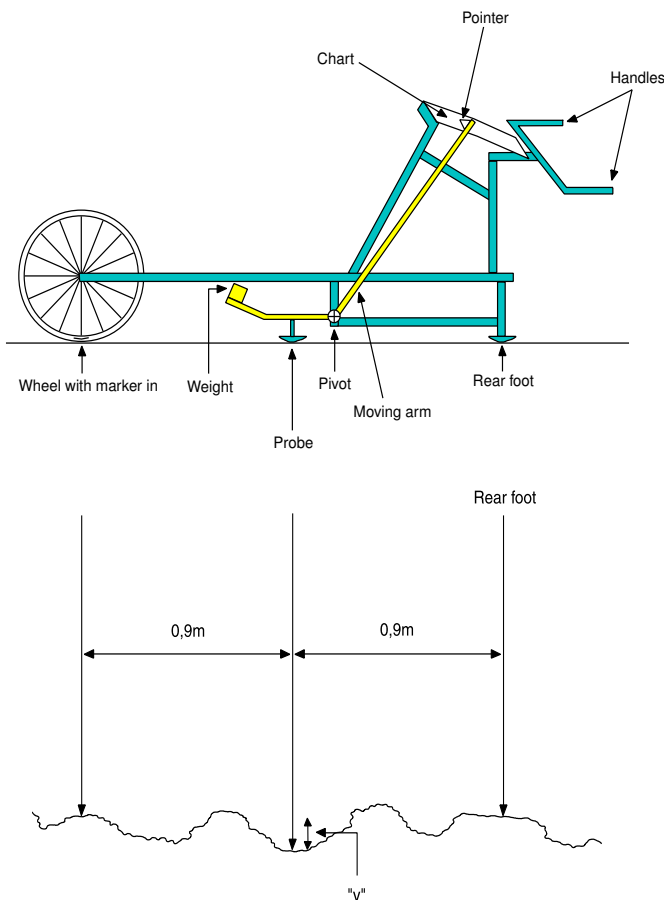

Figure C1 Operation of the Merlin.

between the marks on the chart is S and the thickness of the block T then measurements made on the chart should be multiplied by the scaling factor:

$$\text{Scaling factor} = \frac{10 T}{S}$$

Length of test section used in calibration

If 200 measurements (one at each wheel revolution) are taken using a MERLIN with a 26-inch (415 mm) diameter wheel then the length of the section surveyed will be 415 metres. For shorter or longer sections, a different procedure will be required. The guiding principles are:

- I) The test section should be a minimum of 200 metres long
- II) Take approximately 200 readings per chart. With less than 200 readings the accuracy will decrease and with more the chart becomes cluttered. If the number of readings differs from 200, then the number of crosses counted in from each end of the distribution, to determine D, will also need to be changed. It should be 9 crosses for 180 readings, 11 for 220 readings etc.
- III) Always take measurements with the marker on the wheel in contact with the road. This not only prevents errors due to any variation in radius of the wheel but also avoids operator bias
- IV) Take regularly-spaced measurements over the full length of the test section. This gives the most representative result.
- V) If taking repeat measurements along a section, try to avoid taking readings at the same points on different passes. e.g. start the second series of measurements half a metre from where the first series was started.

TEST SECTION : _____

WHEEL PATH : _____

DATE: _____

OPERATOR : _____

Tally box

1	2	3	4	5	6	7	8	9	10	
										1
										2
										3
										4
										5
										6
										7
										8
										9
										10
										11
										12
										13
										14
										15
										16
										17
										18
										19
										20

A large, empty grid for data collection, consisting of 20 columns and 20 rows. The grid is positioned to the right of the form fields and the tally box.

Figure C2 Merlin data collection form.

Three examples are given below:

- 1) For a 210-metre test section take the measurements in two passes, taking one reading every revolution of the wheel, and offsetting the second pass by half a metre.
- 2) For a 280 metre test section take the measurements in two off-set passes, taking one reading every wheel revolution on the first pass and one reading every two revolutions on the second.
- 3) For a 500-metre test section take the measurements in one pass, taking one measurement every wheel revolution and omitting every fifth measurement. Or, rather than omitting readings, enlarge the tally box and take all 240 measurements. Measure the limits on the chart by counting in 12 crosses rather than 10.

C3 ROUGHNESS SURVEYS USING A RTRRMS

When roughness measurements are needed on more than a few short sections of road, a RTRRMS is recommended. The main advantages of these types of systems are their relative low cost and the high speed of data collection. The systems are capable of surveys at speeds up to 80 km/h, so many hundreds of kilometres of road can be measured in a day.

The TRL Bump Integrator (BI) Unit is a response-type road roughness-measuring device that is mounted in a vehicle. The instrument measures the roughness in terms of the cumulative uni-directional movement between the rear axle and the chassis of a vehicle in motion. The BI system comprises a bump integrator unit and a counter unit and is powered by the 12-volt battery of the vehicle. The NAASRA meter, Linear Displacement Integrator (LDI) and the Mays meter are similar response-type road roughness measuring devices and the survey and calibration procedures will be similar to that used with the TRL BI Unit, described below.

C3.1 *Fitting the TRL BI unit*

The BI unit is mounted in a rear-wheel drive vehicle as shown in Figure C.3. The unit is bolted to the rear floorpan of the vehicle directly above the centre of the rear axle. A 25mm hole needs to be cut in the floorpan and a bracket or hook fixed to the centre of the differential housing of the rear axle

Before each survey, the flexible metal cord from the cylindrical drum of the BI unit is passed through the hole in the floor and hooked onto the bracket on the rear axle. This cord must not touch the sides of the hole. Tension in the cord is maintained by a return spring inside the drum of the BI unit. The BI unit measures the unidirectional movement, in centimetres, between the vehicle chassis and the axle as the vehicle is driven along the road. This is displayed on a counter box, usually fixed to the front passenger fascia.

C3.2 *Survey procedure*

- I) A safe working environment should be maintained at all times. As the vehicle may be moving slower than the majority of other traffic, it should be clearly signed and fitted with flashing lights.
- II) The vehicle should be well maintained and in good working order. The wheels should be properly balanced and the steering geometry correctly aligned. The tyres should not have flat spots or be unduly worn. Tyre pressures should be maintained precisely to the manufacturers specifications and always checked cold. The load in the vehicle must be constant. Ideally the vehicle should contain only the driver and observer, and no other load should be carried.
- III) The engine and suspension system should be fully warmed-up before measurements commence. This can be achieved by driving the vehicle for at least 5km before measurements start.
- IV) The tension cord from the BI unit to the axle should only be connected during the survey. At all other times, the cord should be disconnected to stop unnecessary wear of the BI unit. When attaching the cord to the rear axle, the cord should be pre-tensioned by turning the BI pulley 2.5 turns anti-clockwise. The wire is then wound around the pulley 2 turns in the same direction as the arrow. Note: the pulley must NOT be turned clockwise or suddenly released after being tensioned as the internal spring mechanism could be damaged.

D

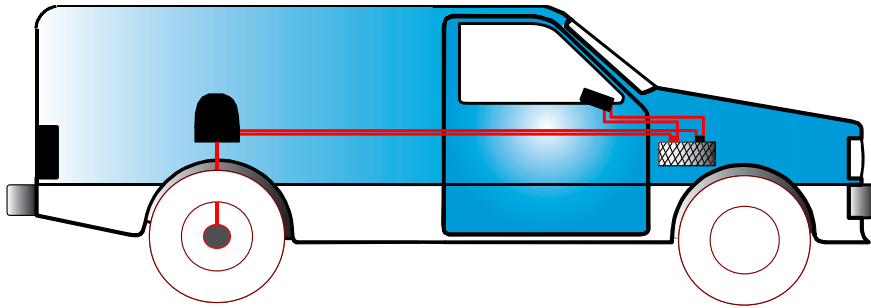

Figure C3 Diagrammatical representation of the TRL Integrator Unit fitted to a vehicle.

- V) When measurements are being taken the vehicle should be driven at constant speed, avoiding acceleration, deceleration and gear changes. This is necessary because the vehicle's response to a given profile varies with speed. To improve reproducibility it is best to operate the RTRRMS at a standard speed of 80 km/h. However, if this speed is unsafe for reasons of traffic, pedestrians or restrictive road geometry, a lower speed of 50 or 32 km/h can be used. **Calibration must be carried out for each operating speed used in the survey.**
- VI) Readings are recorded at half kilometre intervals. This distance should be measured with a precision odometer fitted to the vehicle. The use of the vehicle odometer or kilometre posts is not recommended for survey purposes.
- VII) There are two counters in the recording unit, connected by a changeover switch. This allows the observer to throw the switch at the end of each measurement interval so that the reading can be manually recorded while the other counter is working. The first counter can then be re-set to zero ready for the next changeover.
- VIII) The type of road surfacing and any landmarks should be recorded to aid future analysis of the data. On completion of the survey, the wire cord should be disconnected from the rear axle.
- IX) After the survey, the results should be converted into vehicle response roughness values (VR). The counts measured by the BI are in units of cumulative centimetres of uni-directional movement of the rear axle. These should be converted to vehicle response roughness values using the following equation.

$$VR = \frac{BI \text{ count} \times 10}{\text{Section length}}$$

where

VR = Vehicle Response (mm/km)
BI = No of counts per section (cm)
Section length (kms)

- X) These vehicle response roughness values should then be converted to units of estimated IRI, E[IRI], using a calibration that is unique to the RTRRMS at that time.

C4 CALIBRATION OF A RTRRMS

The RTRRMS must be regularly calibrated against an instrument such as the MERLIN. Calibration should preferably be carried out before the survey and checked on 'control' sites during the survey period to ensure that the RTRRMS remains within calibration. The calibration of the RTRRMS will need to be re-checked before any subsequent surveys or after any part of the suspension of the vehicle is replaced.

The calibration exercise involves comparing the results from the RTRRMS and the MERLIN over several short road sections. The relationship obtained by this comparison can then be used to convert RTRRMS survey results into units of E[IRI]. The recommended practice for roughness calibration is described below.

- i) A minimum of eight sections on the road under evaluation should be selected with roughness levels that span the range of roughness of the road. The sections should have a minimum length of 200m and should be of uniform

roughness over their length. In practice it may be difficult to find long homogeneous sections on very rough roads. In this case it is better to include a shorter section than to omit high roughness sites from the calibration. The section should be straight and flat, with adequate run-up and slow-down lengths and should have no hazards, such as junctions, which may prevent the vehicle travelling in a straight course at constant speed along the whole section.

- II) The roughness of each section should be measured by the RTRRMS at the same vehicle speed that is to be used for the survey. The value of VR (mm/km) should be the mean value of at least three test runs.
- III) The MERLIN should be used to measure the IRI in both wheel paths. The average of these IRI values is then plotted against the vehicle response for each of the test sections. The calibration equation for the RTRRMS is then derived by calculating the best-fit line for the points. This relationship generally has a quadratic form but, depending on the characteristics of the vehicles suspension and the levels of roughness over which the RTRRMS has been calibrated, has also been found to be logarithmic.

$$E[IRI] = a + b VR + c VR^2$$

Where

E[IRI] = Estimated IRI (m/km)

VR = Vehicle Response (mm/km)

a, b and c = constants

The calibration equation can then be used to convert data from the RTRRMS (VR) into units of E[IRI].

C5 INTERPRETATION OF RESULTS

To divide the road into homogeneous sections, such as to minimise the variation in roughness within each section, it is recommended that the cumulative sum method be used (Appendix H).

Appendix D: Pavement layer strength coefficients for structural number (after Paterson, 1985¹)

Pavement layer	Strength coefficient a_i	
Surface course		
Asphalt mixtures (cold or hot premix of low stability)	0.20	
Asphalt concrete (hot premix of high stability) ¹		
$MR_{30} = 1\ 500$ MPa	0.30	
$MR_{30} = 2\ 500$ MPa	0.40	
$MR_{30} = 4\ 000$ MPa or greater	0.45	
Base course		
Granular materials²	For maximum axle loading	
	< 80 kN	> 80 kN
CBR = 30 % ³	0.07	0
CBR = 50 %	0.10	0
CBR = 70 %	0.12	0.10
CBR = 90 %	0.13	0.12
CBR = 110 %	0.14	0.14
Cemented materials⁴		
UCS = 0.7 MPa	0.10	
UCS = 2.0 MPa	0.15	
UCS = 3.5 MPa	0.20	
UCS = 5.0 MPa	0.24	
Bituminous materials⁵	0.32	
Subbase and selected subgrade layers (to total pavement depth of 700 mm)		
Granular materials		
CBR = 5 %	0.06	
CBR = 15 %	0.09	
CBR = 25 %	0.10	
CBR = 50 %	0.12	
CBR = 100 %	0.14	
Cemented materials		
UCS > 0.7 MPa	0.14	

- 1) Applicable only when thickness > 30 mm. MR_{30} = resilient modulus by direct tensile test at 30 °C.
- 2) $a_i = (29.14 \text{ CBR} - 0.1977 \text{ CBR}^2 + 0.00045 \text{ CBR}^3)10^{-4}$; the coefficient a_i may be increased by 60 per cent if CBR > 70 and the subbase is cement- or lime-treated. Note $a_i = 0$ for CBR < 60 when axle loading exceeds 80 kN.
- 3) CBR = California Bearing Ratio (per cent) determined at equilibrium in situ moisture and density conditions.
- 4) $a_i = 0.075 + 0.039 \text{ UCS} - 0.00088 \text{ UCS}^2$; where UCS = Unconfined compressive strength in MPa at 14 days. "Cemented" implies development of tensile strength through Portland cement or lime treatment, or the use of certain flyash, slag, lateritic or ferricrete materials that are self-cementing over time.
- 5) Dense-graded bitumen-treated base of high stiffness, e.g., $MR_{20} = 4\ 000$ MPa, resilient modulus by indirect tensile test at 20 °C.
- 6) $a_i = 0.01 + 0.065 \log_{10} \text{CBR}$.

Appendix E Deflection measurement

E1 INTRODUCTION

The structural integrity of a pavement can be quickly and efficiently assessed by applying a load to the pavement surface and measuring the resulting deflections. The numerous pavement deflection measurement techniques currently in use can be categorised according to the applied load characteristics. Measuring the pavement surface deflection under a static or slow moving load (Benkelman Beam) represents the first generation approach. The next generation involved the application of a dynamic vibratory load (Road Rater and Dynaflect). The third generation deflection equipment (Falling Weight Deflectometer) simulates the effect of a moving wheel load by applying a dynamic impulse load. Future equipment will attempt to measure deflections caused by an actual wheel load moving at highway speeds.

This Appendix gives descriptions, procedures for use, and factors influencing the application of both the Benkelman beam and the Falling Weight Deflectometer. These represent the main methods that may be used to obtain pavement deflections.

E2 BACKGROUND TO DEFLECTION MEASUREMENTS

Early use of deflection data implied the analysis of maximum deflection relative to empirical (experience and/or experiment based) standards. Generally, some statistical measure of the maximum deflection was compared with a “permissible” deflection level. Should the measured value have exceeded the permissible one, an empirical rehabilitation procedure (e.g. an overlay) would have been applied to adequately reduce the measured deflections.

As the understanding of pavement behaviour progressed, the mechanistic approach developed. This approach involves the application of laws of physics in order to understand how the traffic loads are being distributed through the pavement layers. Certain fundamental properties of materials must be known together with the layer thicknesses and load characteristics.

The current mechanistic-empirical approach incorporates elements of both individual approaches. The mechanistic component involves the computation of pavement structural responses (deflections, stresses, strains) within the layers through the use of physical models. The correlation between these responses and the pavement performance is given by the empirical component.

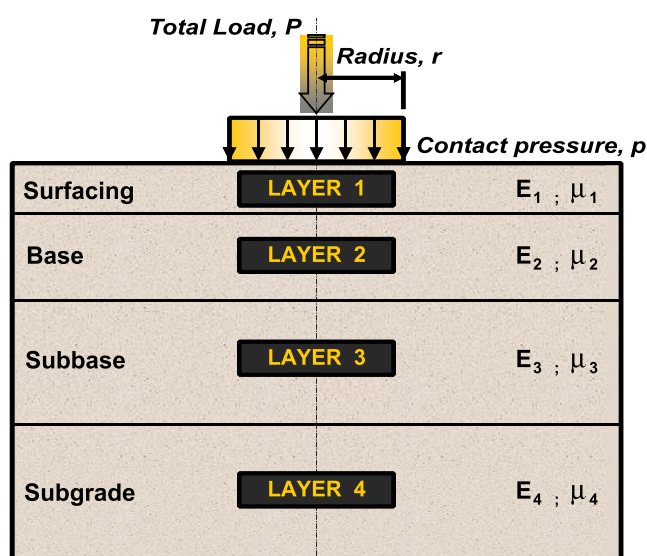

Figure E1 Simplified pavement structure model.

The simplest physical model of a pavement structure consists of a succession of layers, each of them characterised by an elastic modulus, Poisson’s ratio and thickness (see Figure E1). The elastic modulus (E-modulus) is mathematically defined as the constant ratio of stress and strain for that pavement layer’s material. The elastic modulus is expressed in MPa and can typically vary between 30 000 MPa for Portland Cement Concrete to 35 MPa for subgrade soils.

The pavement material is also physically characterised by the Poisson’s ratio, mathematically defined as the ratio of transverse to longitudinal strain of a loaded specimen. Poisson’s ratio is dimensionless and can theoretically vary from 0 to 0.5. Generally, “stiffer” materials will have lower Poisson’s ratios than “softer” materials (e.g. from 0.15 for Portland Cement Concrete to 0.45 for subgrade soils).

E3 DEFLECTION BEAM (BENKELMAN BEAM)

E3.1 General

This is the least expensive instrument for measuring deflections, and was originally devised by A C Benkelman. It is a mechanical device that measures the maximum deflection of a road pavement under the dual rear wheels of a slowly moving loaded lorry. The beam consists of a slender pivoted beam, approximately 3.7m long, supported in a low frame that rests on the road. The frame is fitted with a dial gauge for registering the movement at one end of the pivoted beam, the other end of which rests on the surface of the road. It is shown in Figure E2.

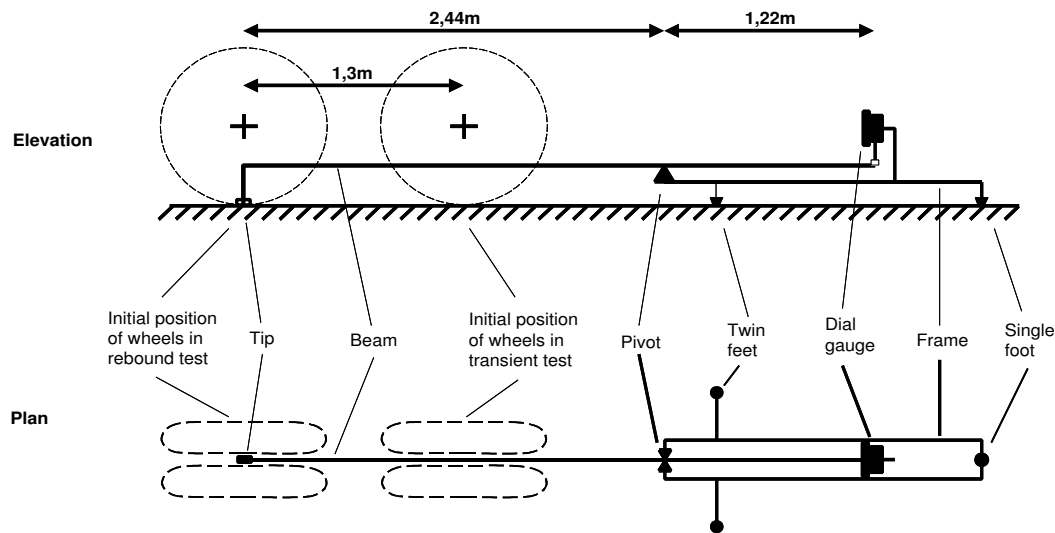

Figure E2 Diagrammatic representation of the Benkelman beam.

E3.2 Deflection beam survey procedure

A safe working environment should be maintained at all times. Many organisations will have on-site safety procedures that should be followed. Where there are no local safety procedures those described in Overseas Road Note 2¹⁹ are recommended.

Testing can be minimised by only taking measurements in the outer wheel path, as this usually is the most heavily trafficked and therefore gives the poorest results. If it is not evident, however, that deflections measured in the outer wheel path are consistently higher than in the inner wheel path, deflection beam measurements should be made in both wheelpaths of the slow lane on dual carriageways and in both lanes of a single carriageway road.

Tests can be made at any frequency, but when measurements are taken at closely spaced regular intervals (say 25 or 50 metres) the additional time and cost implications for the Benkelman beam survey will not normally be merited by gains in data quality. In this respect the automated deflection beam measurements using a Deflectograph can provide a cost-effective alternative, while providing far more comprehensive coverage and detail.

Consequently, when using manual deflection beam measurements, it is recommended that the following strategy be adopted.

- I) Tests are carried out on a basic pattern of 100 or 200-metre spacing.
- II) Additional tests should be undertaken on any areas showing atypical surface distress.
- III) When a deflection value indicates the need for a significantly thicker overlay than is required for the adjacent section, the length of road involved should be determined by additional tests.

E3.3 Timing of deflection surveys

In some cases the moisture content of the road pavement, especially the subgrade, changes seasonally. In these circumstances the tests should be carried out after the rainy season, when the road is at its weakest.

E3.4 Details of test truck

The truck must have dual rear wheels and should be loaded to a standard rear axle load if possible. The axle load must in any case be recorded as load-related corrections to readings may be required. The standard axle load recommended in southern Africa is 80 kN, although TRL recommends the use of a 63.2 kN rear axle load. Over this range of loads the maximum deflection is usually linearly related to the applied load but this may not be the case with all structures or with structures that have suffered considerable damage. The important factor is that the test method and test conditions must be compatible with the deflection criteria and design procedures adopted. The effect of any differences from the original procedures adopted in the deflection design criteria must be established for the roads under investigation.

E3.5 Test method

There are two basic methods²⁰ which are commonly used for operating the deflection beam. These are the transient deflection test and the rebound test.

E3.5.1 *Transient deflection test*

In this test the tip of the beam is inserted between the dual rear-wheel assembly of the loaded truck. The dial gauge is set to zero and the truck then drives slowly forward. As the wheels approach the tip of the beam, the road surface deflects downwards (loading deflection) and the movement is registered by the dial gauge. As the wheels move away from the tip of the beam, the road surface recovers (recovery deflection) and the dial gauge reading returns to approximately zero. The test procedure is summarised below.

- I) Mark the point, in the vergeside wheelpath, at which the deflection is to be measured and position the lorry so that the rear wheels are 1.3m behind the marked point.
- II) Insert the deflection beam between the twin rear wheels until its measuring tip rests on the marked point. Insert a second beam between the offside wheels, if deflections are to be measured in both wheelpaths. It is helpful in positioning the lorry and aligning the beams if a pointer is fixed to the lorry 1.3m in front of each pair of rear wheels.
- III) Adjust the footscrews on the frame of the beam to ensure that the frame is level transversely and that the pivoted arm is free to move. Adjust the dial gauge to zero and turn the buzzer on. Record the dial gauge reading which should be zero or some small positive or negative number.
- VI) The maximum and final reading of the dial gauge should be recorded while the lorry is driven slowly forward to a point at least 5m in front of the marked point. The buzzer should remain on until the final reading is taken. Care must be taken to ensure that a wheel does not touch the beam. If it does the test should be repeated.
- VII) The transient deflection is the average of the loading and recovery deflections. Because of the 2:1 ratio of the beam geometry over the pivot point (see Figure E2) the transient deflection is calculated by either:
 - VII) Adding the difference between initial and maximum dial gauge readings to the difference between maximum and final dial gauge readings, or,
 - VIII) Calculating the loading deflection, as double the difference between the initial and maximum values, and the recovery deflection, as double the difference between the maximum and final readings and then calculating the mean of the two deflections.
- IX) At least two tests should be carried out at each chainage and the mean value is used to represent the transient test result. If the results of the two tests do not fall within the repeatability limits described in Table E1 then a third test should be carried out.

Mean deflection (mm)	Max. permissible difference between the two tests (mm)
< 0,10	0,02
0,10 - 0,30	0,03
0,31 - 0,50	0,04
0,51 - 1,00	0,05
> 1,00	0,06

Table E1 Repeatability of duplicate transient deflection tests.

E3.5.2 Rebound deflection test

This is probably the most commonly used method which, while not as comprehensive as the transient method, allows a greater production rate with less need for repeat measurements (e.g. due to the tyre touching the beam when guide pointers are not used on the lorry). Because the rebound deflection can be influenced by the length of time during which the loading wheels are stationary over the test point care must be taken over the exact procedure used. The rebound test is not recommended by TRL for use on roads that may 'creep' under the effect of the stationary loading wheels.

For the rebound deflection test the dual wheels are positioned immediately above the test point and the measuring tip of the beam is placed on the test point and between the dual wheels. The beam is adjusted in the same way as for the transient test and when the initial reading has been noted, the lorry is driven forward at creep speed until the wheels are far enough away to have no influence upon the deflection beam. The final dial gauge reading is recorded and the 'rebound deflection' is twice the difference between the initial and final dial gauge readings.

Whichever method is adopted for the deflection beam measurements, the possible effect of plastic flow upon the results should be noted, although this is only likely to be significant for thicker or relatively fresh asphalts. When an asphalt surfacing material flows plastically, it squeezes upwards between the dual loading wheels of the deflection truck which, in the transient deflection test, reduces the transient loading deflection because the upward movement of the material counteracts the downward movement of the pavement. The transient recovery deflection that is measured may be correct but further plastic movement of the raised surfacing material can occur during the time taken for the wheels to move from the test point to the final position, thereby causing an error in the recovery deflection reading. It is usually very clear from the test results when plastic flow occurs and testing should be stopped to avoid recording erroneous data.

In the rebound test greater plastic flow will be induced in susceptible materials because of the time the wheels remain stationary over the test point. When the truck is driven forward the road surface 'rebounds' but an indeterminate amount of recovery of the displaced surfacing material can occur. There is thus no clear indication from the simple rebound test when plastic flow occurs.

E3.6 Analysis of deflection survey data

Deflection readings can be affected by a number of factors that should be taken into account before the results can be interpreted. These are the temperature of the road, plastic flow of the surfacing between the loading wheels, seasonal effects and the size of the deflection bowl.

E3.6.1 Road temperature

The stiffness of asphalt surfacings will change with temperature and therefore the magnitude of deflection can also change. The temperature of the bituminous surfacing is recorded when the deflection measurement is taken, thus allowing the value of deflection to be corrected to a standard temperature. It is recommended that 35°C, measured at a depth of 40mm in the

surfacing, is a suitable standard temperature. Fortunately, it is often found that little or no correction is required when the road surfacing is either old and age hardened or relatively thin, which is likely to be the general case in this country.

If, however, there is a need to adjust for temperature (thicker, newer asphalt surfaces) the following should be noted. The relation between temperature and deflection for a particular pavement is obtained by studying the change in deflection on a number of test points as the temperature rises from early morning to midday²⁰. As it is not possible to produce general correction curves to cover all roads, it is therefore necessary to establish the deflection/temperature relationship for each project.

E3.6.2 Seasonal effects

In areas where the moisture content of the subgrade changes seasonally, the deflection will also change. For overlay design purposes, it is usual to use values that are representative of the most adverse seasonal conditions and it is therefore normal practice to carry out surveys just after the rainy season. If this cannot be done, an attempt should be made to correct for the seasonal effect. However, this requires a considerable data bank of deflection results and rainfall records before reliable corrections can be made.

E3.6.3 Size of deflection bowl

The size of the deflection bowl can occasionally be so large that the front feet of the deflection beam lie within the bowl at the beginning of the transient deflection test. If this happens, the loading and recovery deflection will differ. The simplest way to check whether the differences in loading and recovery deflection are caused by the size of the bowl is to place the tip of another beam close to the front feet of the measurement beam at the beginning of the transient test. This second beam can be used to measure any subsequent movement of the feet of the first beam as the truck moves forward. If feet movements larger than 0.06mm are observed only the recovery part of the deflection cycle should be used for estimating the value of transient deflection.

E3.6.4 Data processing

After all measurements have been made, and any corrections applied to the raw data, it is then convenient to plot the deflection profile of the road for each lane. When measurements in both wheel paths have been made, only the larger deflection of either wheel path at each chainage is used. Any areas showing exceptionally high deflections that may need reconstruction or special treatment can then be identified.

The deflection profile is then used to divide the road into homogeneous sections, in such a way as to minimise variations in deflections within each section. The minimum length of these sections should be compatible with the frequency of thickness adjustments that can sensibly be made by the paving machine, whilst still maintaining satisfactory finished levels. When selecting the sections the topography, subgrade type, pavement construction and maintenance history should all be considered.

A number of statistical techniques can be used to divide deflection data into homogeneous sections. The recommended technique is the cumulative sum method, where plots of the cumulative sums of deviations from the mean deflection against chainage can be used to discern the sections. Details of this approach are given in Appendix H.

E4 FALLING WEIGHT DEFLECTOMETER (FWD)

E4.1 General

The Falling Weight Deflectometer (FWD) simulates the effect of actual traffic-induced loads by dropping onto the pavement surface a constant weight from variable heights. A diagram is shown in Figure E3. The FWD is generally placed on a semi-trailer and equipped with its own power source (generator / batteries). It weighs about 1 tonne (1.5 tonne for the airport version) and can comfortably travel, on surfaced roads, at 100 km/h. A distance-measuring wheel is also attached to the semi-trailer, for relative and global distance measurements.

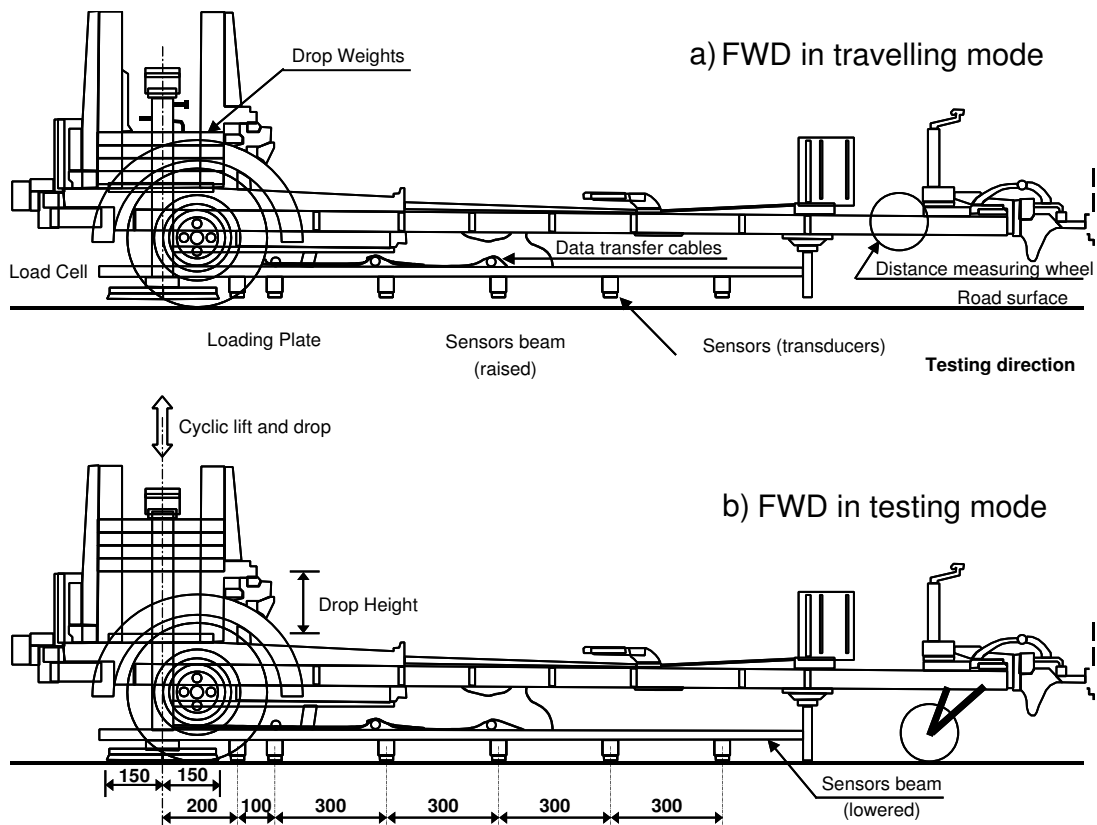

Figure E3 Diagrammatic representation of the FWD.

A number of detachable weights are locked on a hydraulic piston that facilitates their quick and precise lift. The weights are thereafter dropped from a predetermined height. A circular, flexible, loading plate (150 mm radius) ensures the smooth load transfer between the dropping weights and the potentially uneven pavement surface. A load cell, placed directly under the dropping weight, accurately measures the loading level. The resultant pavement surface deflections are measured by 9 sensors / transducers placed under a sensors beam at the following offsets (from the loading plate's centre): 0 / 150 / 200 / 300 / 600 / 900 / 1200 / 1500 / 1800 mm. Multiple data transfer cables, also attached to the sensors beam, ensure the communication between the load cell / sensors / FWD engines and the central computer.

E4.2 Measurement procedure

All the relevant "under traffic" test safety measures apply.

Establishing a concise but clear and consistent testing reference system prior to the commencement of testing is critical. The reference system should include the following:

a) General information

Date, operator(s), FWD serial number, road ID (for network testing), measurement units (metric / imperial), test start and end chainages, test spacing (distance between adjacent test points); sensors spacing (depending on the pavement layer thicknesses);

b) Test point information and parameters

Number and sequence of drops (in terms of corresponding load levels); air, surface and in-depth temperatures; pavement cracking type, extent and magnitude; road profile (e.g. fill/cut, to reflect potential water ingress); change(s) in the pavement structure; and underground structures (e.g. culverts, pipes, which can significantly affect the deflection magnitude).

The number and sequence of drops can be set up differently in up to five series. The operator can apply any or all of these series at a test point. Generally, one series of two drops (4 tonne each) is usually applied for all test points.

The air, surface and in-depth temperatures are usually determined at the start and end of a testing session. Should any temperature change occur during testing, the operator should repeat FWD measurements. It is usually more beneficial to continuously monitor the temperatures.

All relevant calibrations (see next section) must be undertaken as required. A large amount of deflection data could prove incorrect and, therefore, useless should the system malfunction at any time.

While moving between two adjacent points the sensors beam must be raised, irrespective of travelling speed. Once the FWD has stopped, the sensors beam is lowered together with the loading plate. The operator inputs the test point information and, automatically, the weights are raised and dropped from a "test" height for an in-built, on-the-spot system check. Once the operator is satisfied with the system pre-test data, the weights are automatically raised and dropped to and from the predetermined height(s) as many times as required. After each drop, the relevant data is sent to the computer, which displays it. The operator can interrupt the automatic testing sequence at any time and restart and /or continue it manually (drop by drop), if so necessary.

E4.3 Calibrations

Three types of calibration of the sensors are done, namely absolute, reference and relative. Absolute calibration is done in the factory, at the time of manufacture, while designated agents typically undertake reference calibration annually, also indoors. The absolute and reference calibration results should be recorded by the agents in calibration certificates and be available for inspection at all times.

The relative calibration is usually done monthly and/or at the start of every new project, in approximately 4 hours. During this calibration, the sensors are placed one on top of each other and subjected to a standard vertical load. If all the sensors are in good condition, their readings should be sensibly equal.

The load cell should be tested at the start and end of each testing session by plotting, on the computer screen, its output curve, for a standard drop. This plotting option is available on most FWD equipment. If the load cell is in good condition, its output curve shall have a continuous sinusoidal shape.

Generally, no other calibration is required, even when the equipment has to travel on rough roads or pull aside on grass.

E4.4 Output

At present, the FWD data acquisition software runs in an MS-DOS operating system. The testing output is stored in specific text files with extensions such as: *.f10*, *.f20* or *.fwd* (depending on the software type and version). These text files can be easily viewed, in MS-DOS, with the "Edit *file_name.f10/f20/fwd*" command.

The general information is stored in the file's header. The initial test drop parameters and results follow. Subsequently, all drop loads and their corresponding pavement surface deflections are recorded separately, though grouped per test point. The test point information is generally recorded per point, though it can also be recorded for each drop.

Microsoft Excel can be satisfactorily used to import and process these files. Once the potential user tries to open such a file, the text import procedure is automatically started and a "delimited" file type is assigned. As this default file type is convenient, the user can subsequently choose the delimiter type for converting the text to columns. For the purposes of FWD data analysis, the most adequate delimiter type is "space". The resultant file can be saved as an Excel spreadsheet and used for further processing.

It is however recommended that the FWD service provider processes these files according to the Client's requirements. Inherent measurement errors can be easily overlooked if the processing personnel do not have the required expertise.

E4.5 Deflection bowl parameters

The deflections recorded at a test point constitute that point's deflection bowl (see Figure E4a). The maximum deflection, measured directly under the load, can serve as a good indicator of the overall pavement strength. The inner deflections (closer to the loading plate) relate to the upper layers (surfacing, base, subbase) strength whereas the outer ones relate to the

lower layers (selected, subgrade). For this reason, a number of deflection bowl parameters are derived from measured deflections (see Figure E4b).

A number of software packages (e.g. IDMP) have been specifically developed for FWD data conversion and processing. The output includes deflection bowl parameters, allowable traffic, etc.

E4.6 Backcalculation

Currently complete deflection bowls are used in an iterative procedure, known as backcalculation, to estimate the pavement layer E-moduli. The straightforward goal of the backcalculation process is to estimate a set of layer E-moduli that best match the measured and calculated deflections, at all offsets.

A physical model is assumed, with estimated E-moduli and Poisson's ratios. The layer thicknesses are considered known. A set of theoretical deflections is then mathematically derived (at the same offsets as the FWD sensors) based on the estimated E-moduli and the traffic loading. This set of computed deflections is compared with the FWD measured one. Based on the difference between the two sets of deflections, the estimated E-moduli are adjusted and the theoretical deflections re-computed. This process is iterated until the difference between the computed and measured deflections is being reduced to a minimum (that is, 5-10%).

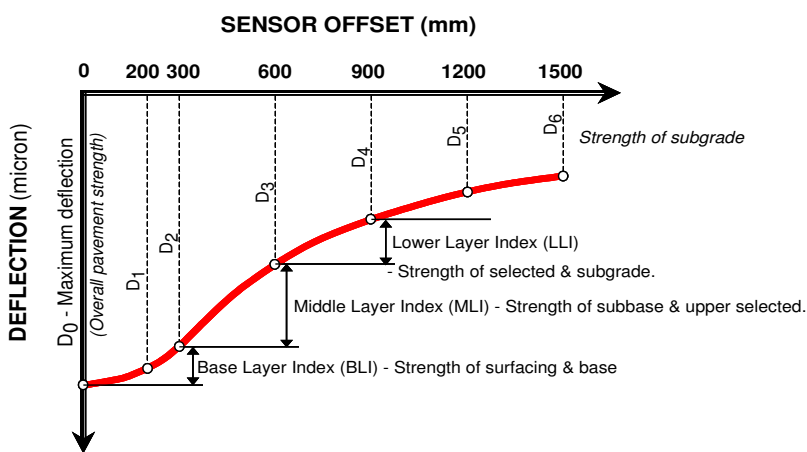

a) Deflection Bowl Parameters

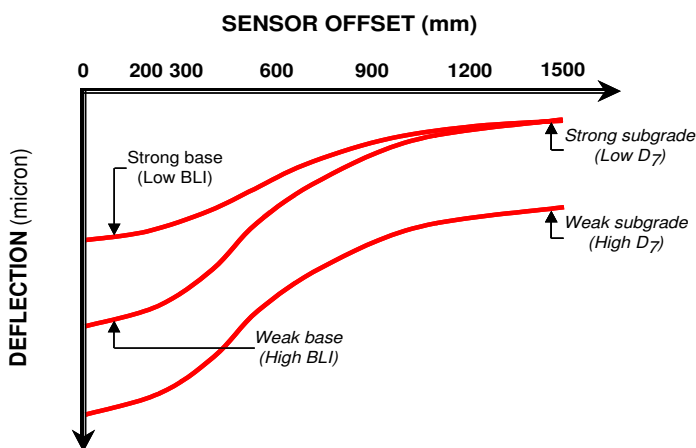

b) Pavement Layers Strength

Figure E4 Deflection bowl parameters.

Appendix F: Test pit profiles

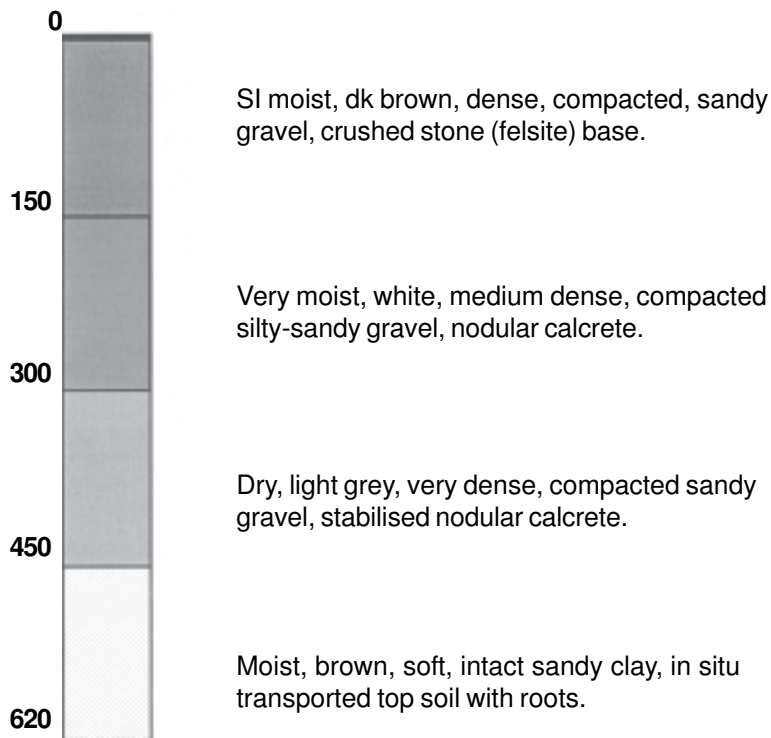

Example of a soil profile prepared in Microsoft Excel.

SOIL PROFILING DESCRIPTORS

MCCSSO

MOISTURE:

Dry – powdery and dusty
Slightly moist – would require water to attain OMC
Moist – about OMC
Very moist – requires drying to get to OMC
Wet – below water table

COLOUR:

At same moisture content – about saturation but requires note of in situ colour

Mottled – small areas of different colour
Blotched – larger areas (> 75 mm)

CONSISTENCY

Cohesive soils (slow-draining silts and clays or combinations with sand)

Classification	Description
<i>Very soft</i>	Easily moulded in fingers – pick head can be pushed in to shaft of handle
<i>Soft</i>	Easily penetrated by thumb – sharp end of pick penetrates 30-40 mm – moulded by fingers with some pressure
<i>Firm</i>	Indented by thumb with effort – sharp end of pick penetrates 10 mm – difficult to mould with fingers
<i>Stiff</i>	Penetrated by thumb nail – slight indentation produced by pushing pick point into soil – cannot be moulded by fingers
<i>Very stiff</i>	Indented by thumb nail with difficulty – slight indentation produced by blow of pick point

Granular soils (free-draining gravels and sands)

Classification	Description
<i>Very loose</i>	Rumbles very easily when scraped with pick
<i>Loose</i>	Small resistance to penetration by sharp end of geological pick
<i>Medium dense</i>	Considerable resistance to penetration by sharp end of geological pick
<i>Dense</i>	Very high resistance to penetration by sharp end of geological pick – requires many blows to excavate
<i>Very dense</i>	High resistance to repeated blows of geological pick – requires power tools to excavate

STRUCTURE:

Intact – absence of fissures or joints
Fissured – contains closed joints, with or without staining by oxides
Slickensided – polished or shiny fissures indicative of movement in the soil
Shattered – opened fissures that permit the entry of air – often cubical or granular and indicate past drying out
Micro-shattered – extreme shattering resulting in sand-sized grains – associated with highly clayey materials
 Residual structures such as *foliation, lamination, stratification* – inherited from parent materials

GRAIN SIZE:

Grain size (mm)	Classification
< 0.002	<i>Clay</i> (greasy feel)
.002 – 0.075	<i>Silt</i> (gritty on teeth, needs microscope to see)
0.075 – 0.2	<i>Fine sand</i> (gritty but visible through hand lens)
0.2 – 0.6	<i>Medium sand</i>
0.6 – 2.5	<i>Coarse sand</i>
2.5 – 12	<i>Fine gravel</i>
12 – 50	<i>Medium gravel</i>
50 – 200	<i>Coarse gravel</i>
> 200	<i>Boulders</i>

Appendix G: Equilibrium and predicted moisture content

As discussed in the main text, the in situ moisture content can be evaluated in terms of expected equilibrium moisture contents (EMC) and predicted equilibrium to optimum moisture content ratios (EMC/OMC_m)². Various models are available for the former, the simplest being:

Equation G.1

$$EMC = 0.68 (OMC_m) + 0.031 (LS)(P425^{0.7}) - 1.1(K) \%$$

where OMC_m = Mod AASHTO optimum moisture content
 LS = bar linear shrinkage,
 P425 = percentage passing 0.425 mm sieve,
 and K = 1 for base and 0 for subbase and subgrade.

The EMC/OMC_m ratio in Botswana will differ from layer to layer as follows:

All unbound subgrade materials

Equation G.2

$$EMC/OMC_m = 0.13(LS) + 0.63(\log_e(100 + Im)) + 0.13(P75/OMC_m) - 0.0071(LS)(P425^{0.7}) + 0.011(PL) - 2.36 \%$$

where Im = Thornthwaites moisture index,
 P75 = percentage passing 0.075 mm sieve,
 PL = Plastic limit, and

the other parameters are as defined previously.

Subbase

$$EMC/OMC_m = 0.707$$

Base course

$$EMC/OMC_m = 0.56$$

Appendix H: Cumulative sum method for identifying uniform sections

H1 Introduction

Interpretation of the field data to define sections having uniform characteristics in terms of a given parameter (e.g. roughness, deflections, etc) can sometimes be aided by the use of the cumulative sum (Cusum) approach. This is not always applicable, although it can be attempted with any data set, but is most effective when data have been collected at regular and fairly frequent intervals. Hence, it is most often applied to deflection, roughness and rut depth measurements.

From the outset, it should be kept in mind that this approach is just one of various methods that could be used, but that the principal aim is to help delineate uniform sections. Thus if a graphical inspection of the data values already gives clear practical delineation of sections, there is actually no need to use further processing.

It should also be noted that some experience helps in expediting the process where, for example, the data values can be seen as being combinable to define a practical uniform section without concern for minor differentiations. An important point, however, is that the standard deviation is normally used to define characteristic (typically 90th percentile) properties and this can become unrealistically high if data which are significantly disparate are combined for a “uniform” section.

Consequently, the final check on reasonableness must always be a visual comparison of the calculated characteristic value for a section with the raw data values. This will show whether the delineation is realistic.

H2 Cumulative sum definition

The cumulative sum is calculated in the following way.

Equation H.1

$$S_i = x_i - x_m + S_{i-1}$$

where

- x_i = Parameter value at chainage i
- x_m = Mean parameter value for the whole data set
- S_i = Cumulative sum of the deviations from the mean parameter value at chainage i
- S_{i-1} = Cumulated sum up to the previous position (chainage $i-1$)

H3 Using the cumulative sum method

Using cumulative sums, the extent to which the measured individual parameter values on sections of road vary from the mean value of the whole surveyed length can be determined. Distinct changes in the slope of the line connecting the plotted cumulative sums will indicate boundaries between homogeneous sections.

This will be seen more clearly in the examples below, and arises from the fact that relatively uniform sections will have parameter values that differ reasonably consistently from a selected datum value, in this case the overall mean. Thus a uniform section having higher than average values, for example, will cumulate an increasing positive divergence from the mean, and one with lower than average values will give an increasing negative divergence. The more consistent the uniform section values, the closer the divergences approximate to a straight line.

Consequently the Cusum method can clearly show the points at which changes in the field data values would suggest different uniform sections.

H4 Final processing to define characteristic values of uniform sections

The final stage of the procedure is to calculate the representative parameter value for each identified homogeneous section of the road. This entails calculating the mean and standard deviation for each uniform section. These are then used to define, most commonly, the 90th percentile value, which can be calculated as follows:

Representative value = mean + 1.28 standard deviation.

If such a procedure is used for parameters in which lower values represent poorer conditions (such as material CBRs), the representative value will be given by subtraction of the standard deviation component.

Other percentile values could be used, which would use a different multiplier for the standard deviation. These come from statistical tables (based on the assumption of normal, or Gaussian, distribution of the data values) with other commonly used values being the 80th percentile and the 95th percentile. Multipliers associated with these different percentiles are 0.84 and 1.64 respectively. The proposed method will tend to separate out areas of poorer condition or areas that warrant special treatment or reconstruction and therefore the distribution of the remaining parameter measurements will approximate to a normal distribution

H5 Examples of the use of the Cusum method

This section gives some examples on the use of the Cusum method, and highlights some of the important points to note when using such a method.

H5.1 Example 1, Plasticity Index (PI) values

Figure H.1 gives a complete data set for PI values determined over a 17 km section, in which one data value has been measured for each one kilometre section. These are shown as the first two columns of data, giving the position (chainage) and the PI value (x_i). The average for all the PI values (the data set) is given at the foot of the data column: 24.41 (x_m).

The next column then gives the difference between each individual data value and the mean ($x_i - x_m$), and the last column gives the cumulative sum of the differences. The first graph to the right of the data set simply shows the data values plotted against chainage on an x-y basis, and the lower graph shows the Cusum plot.

There are several things to note. First, this method of plotting

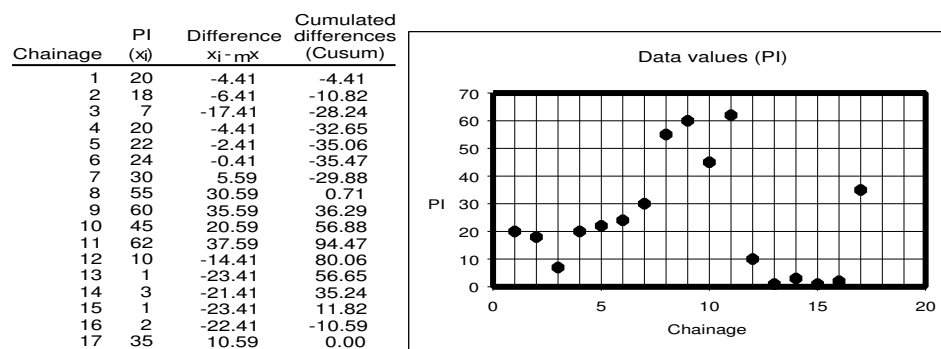

Average, $x_m = 24.41$

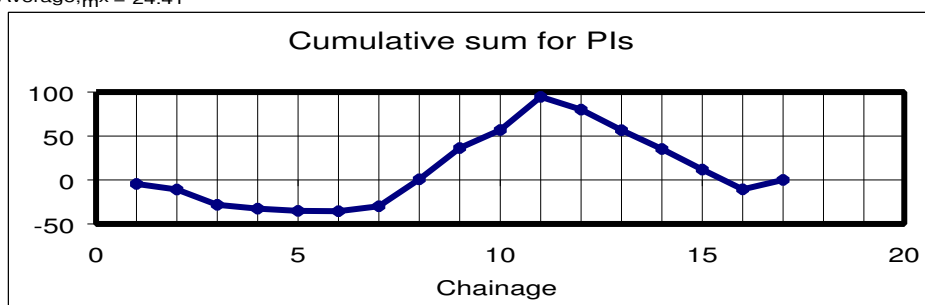

Figure H.1 Data and plots for Example 1

the raw data, while simple to do, is somewhat misleading in that each value is shown at a specific chainage value. For this type of data it is assumed that any PI value in fact represents the typical value over the whole sub-section of road, i.e. that the first value (20) applies from chainage 0 to 1, the second (18) from chainage 1 to 2, and so on. Thus it would probably be more realistic to either show the data values at the mid-point chainage positions (i.e., 0.5 km, 1.5 km, etc) as an x-y plot, or alternatively as bars from chainages 0 to 1, 1 to 2, 2 to 3, etc. While this is not critical, it is important that the significance of the data representation is understood, as it will affect subsequent processing.

The second point to note, from the raw data value plot, is that from observation it is clear that there are at least four likely divisions into uniform sections. It can be seen that, with the exception of the significantly lower value for chainage 2 to 3 (PI 7, plotted at chainage 3), the PIs up to km 7 are effectively in the range 20 to 30. This immediately highlights the need for a further consideration of the data values, and clarification of the validity and representativeness of the lower value. This is because the practical difference between a PI of 7 and PIs of 20 to 30 is highly significant. The next section, plotted at points km 8 to 11, has much higher PIs (45 to 62), with those for km 12 to 16 low, and a last high point being PI 35 for km 17.

The Cusum representation (the lower graph) shows two distinct nominally linear sections, from km 7 to 11, and from km 11 to 16, with a distinct change in gradient. These represent the sections having the high and the low PIs noted above. The gradients of the lines indicate that the first of these sections, with a relatively high positive gradient, is reasonably uniform with **higher than average PIs (positive gradient). Conversely, the second of these sections has a distinct negative gradient, indicating lower than average values.**

The first part of the Cusum plot shows a downward trend line to km 7, with a slightly higher dip from km 2 to 3, due to the PI value of 7 for the section km 2 to 3. As the gradient for this section, apart from the dip, is reasonably uniform and slightly negative, the plot indicates that the data values are typically somewhat lower than the overall average.

It might therefore be inferred from the Cusum plot that uniform sections could be taken as 0 to 7 km, 7 to 11 km, and 11 to 16 km, with the last single point (PI 35) indicating a final section. Two factors should be considered prior to making such a conclusion: firstly, is this a realistic delineation; secondly, which values should be averaged to provide characteristic data (including standard deviations).

Reviewing the raw data value plot provides this basis, and immediately indicates the need for caution when interpreting the data. It is apparent that the low PI value for km 3 (representing km 2 to 3) could represent a totally different condition to the rest of the section. Consequently, it should not be included in the averaging process as it will tend to give a lower (unrealistic) average for the section generally, with a higher standard deviation (indicating greater scatter). As highlighted earlier, further investigation of the validity of this value and possible extent of the different condition is actually needed.

Thus for the first uniform section, which in fact covers km 0 through to km 7, an average for characterising the section would use raw data for chainages 1 to 7 in the table, excluding the value for km 3.

The second section (km 7 to 11 from the Cusum plot) represents very high PI but it is clear that the actual value for km 7 should not be included in the average.

The third section indicated (km 11 to 16) would not include the value for km 11, in line with the previous comments, and also calls for some judgement. The reason for this is that four of the data values (representing actual chainage from km 12 to 16 inclusive) are very low (PIs from 1 to 3), while the value for point 12 (representing actual chainage from km 11 to 12) is markedly higher (PI 10). In reality, this difference is significant and clarification of the higher PI would be required while the rest of the section could be characterised by averaging the lower uniform values.

Now this simple example, which is not perhaps a typical practical application, has been used to highlight the importance of some understanding of the data, and to avoid blind usage of a method to aid practical delineation of data sets. Similar practical consideration should be given to any data processing, but is especially true when data are limited as in this example, and are effectively already representative values for substantial lengths. Other practical cases where this might occur are for delineating sections based on CBR data or on roughness data when each data value is regarded as representing finite lengths of the road.

H5.2 Example 2, deflection data values

This example is where each value actually represents a distinct point on the road where the measurement was taken. In this case, only a few of the actual readings taken are shown (there are actually several thousand data points) for deflection data obtained by Deflectograph for the Rasesa – Monemetsana section.

First of all this illustrates that the amount of data is immaterial once it is in a spreadsheet: processing follows the same procedure and the time taken is little different as the simple formulas are copied for all data. Second, it is probably a more typical application but, again, it should be emphasised that the Cusum process is just an aid to delineating uniform sections and should not be considered other than a guide. Final classification will still normally require some judgement.

Figure H.2 gives some of the data for example 2, together with a complete plot of the data values over almost 25 km, and the Cusum graph. First it should be noted that the data has already been processed ready for graphical representation. In this case, this means all the chainage values have been corrected to tie in with kilometre posts, and the actual deflection values for the lefthand side (LHS) beam have had 1.5 mm added. The last process is simply an expedient to show both beam values against the y-axis rather than have them effectively plot on top of each other. Thus the zero deflection datum for the upper plot (the LHS beam values) is actually 1.5 mm.

It should also be noted that the average used in the Cusum analysis is simply the average of the plot values, including the added 1.5 mm on each value. This has no effect whatsoever on the Cusum process. The only important point is that any subsequent averaging and evaluation of standard deviations must be done using the real data values.

As in the previous example, the numeric data is given as position (x-axis value), and in this case two columns of deflection data (y-axis values), with the LHS values being the real value plus 1.5 mm as just discussed. The next two columns then show the cumulative sum data: the average values of the two data sets (to which each individual value is compared) are at the top of these columns. These are shown as 0.24663364 and 1.724723805 for right-hand and left-hand sides respectively, and are simply the spreadsheet function averages. These would normally be notated as 0.25 mm and 0.22 mm (when 1.5 mm is subtracted for the LHS beam) in any discussion. However, for data processing purposes the use of these values (showing 9 decimal places) is perfectly acceptable.

All the deflection data are shown on the upper plot and, in line with the very low overall average deflections, it will be seen that most deflections are less than half a millimetre. The graph also clearly shows that both beams give similar patterns as would be expected. It should be noted that there is actually a gap in the data from about km 54.3 to km 55, although a line is shown joining the values. The reason for the gap should be established in actual processing but is outside the scope of this example, which is only to provide insight into the use of the Cusum method.

The lower graph gives the Cusum results. This definitely gives a very distinct delineation of several major sections, the first major change occurring at about km 44.9 (the actual point can be identified from the plot using the latest version of Excel, or from examination of the data values). Reference to the upper plot suggests that this would satisfactorily define a uniform section. Other distinct changes (ignoring the data gap from km 54. to km 55) are evident at approximately km 50.8, km 51.6, km 53.6, and km 58.8.

Prior to detailed analysis, it should be recalled that gradients of the Cusum plot reflect relative deviations from the mean and, most important, that similar gradients represent similar data values. This fact provides further assistance in selection of uniform sections.

For this example, the first section is well defined to km 44.9 and, ostensibly, a second section would be to approximately km 50.8. A closer examination of the Cusum plot, however, indicates that apart from the slight rise in gradient from km 50.8 to about km 51.6, the overall gradient from km 44.9 to km 53.6 is similar. This suggests that, although there is a definite need to treat the section from km 50.8 to km 51.6 as a different uniform section, if these values were excluded from the calculation, it would be appropriate to consider all the other data from km 44.9 to km 53.6 as a uniform section.

The implication is that, instead of averaging two separate sets of data on each side of km 50.8 and 51.6, only one set is used once the values pertaining to this short intermediate section are excluded. While there is technically nothing wrong in treating them as different data sets, which are likely to give similar results, the proposed approach appears more realistic: the section is basically uniform with a short intermediate section having significantly higher deflections which might relate to some specific field conditions. This would be clarified from other survey data.

Extending this reasoning, it will also be seen that the last section from about km 59.0 also has much the same gradient (confirmed by straight edge or ruler), apart from a very localised deviation at about km 62.2, indicating similar conditions. However, as this is already a substantial length it can be treated separately even though the results should be similar.

Other sectioning from the Cusum plot is suggested from about km 53.6 to km 55.6 (ignoring the slope change where there is no data, but looking at the gradient, and the raw data), and from about km 55.6 to km 59.0.

This would give a total of nine uniform sections based on deflection, including the very localised high deflection area around km 62, as shown in Table H.1 following. It should be noted, however, that in this case given the general low deflections from km 44.9 onwards, a more practical approach might be to regard the whole section as uniform with the exception of the significant higher deflection sections. These would be from km 50.8 to 51.6 (section 3), km 53.6 to 55.6 (section 5) and around km 62.2 (section 8). The results from this delineation are also given in Table H.1 for comparison.

Data for graph

Position x-axis	RHS beam y1	LHS beam plus 1.5mm		Average y1	Average y2
		y2	0.246663364 Cusum 1	1.724723805 Cusum 2	
37.9830585	0.49	2.33	0.243336636	0.605276195	
37.98870567	0.34	2.26	0.336673272	1.14055239	
37.99435283	0.41	2.23	0.500009908	1.645828586	
38	0.4	2.16	0.653346544	2.081104781	
38.00564717	0.4	2.19	0.806683181	2.546380976	
38.01129433	0.41	1.91	0.970019817	2.731657171	
38.0169415	0.38	1.85	1.103356453	2.856933366	
38.02258866	0.32	1.84	1.176693089	2.972209562	
38.02823583	0.45	1.79	1.380029725	3.037485757	
38.03388299	0.52	1.77	1.653366361	3.082761952	
38.03953016	0.5	1.77	1.906702997	3.128038147	
38.04517732	0.48	1.84	2.140039633	3.243314342	
38.05082449	0.45	1.91	2.34337627	3.428590538	
38.05647165	0.38	1.79	2.476712906	3.493866733	
38.06211882	0.49	1.75	2.720049542	3.519142928	
38.07341315	0.37	1.73	2.843386178	3.524419123	
38.07906031	0.32	1.83	2.916722814	3.629695318	
38.08470748	0.38	1.83	3.05005945	3.734971514	
38.09035464	0.28	1.85	3.083396086	3.860247709	
38.09600181	0.35	1.95	3.186732722	4.085523904	
38.10164897	0.33	1.91	3.270069358	4.270800099	
38.10729614	0.35	1.96	3.373405995	4.506076294	
38.1129433	0.37	1.88	3.496742631	4.661352489	
38.12423763	0.45	2	3.700079267	4.936628685	
38.1298848	0.34	2.05	3.793415903	5.26190488	
38.14117913	0.31	1.99	3.856752539	5.527181075	
38.14682629	0.29	1.94	3.900089175	5.74245727	
38.15247346	0.27	1.89	3.923425811	5.907733465	
38.15812062	0.4	1.8	4.076762447	5.983009661	
.....etc					

Small part of the actual data set, prepared for plotting

Rasesa - Monemetsana
Processed deflection data - complete surveyed length

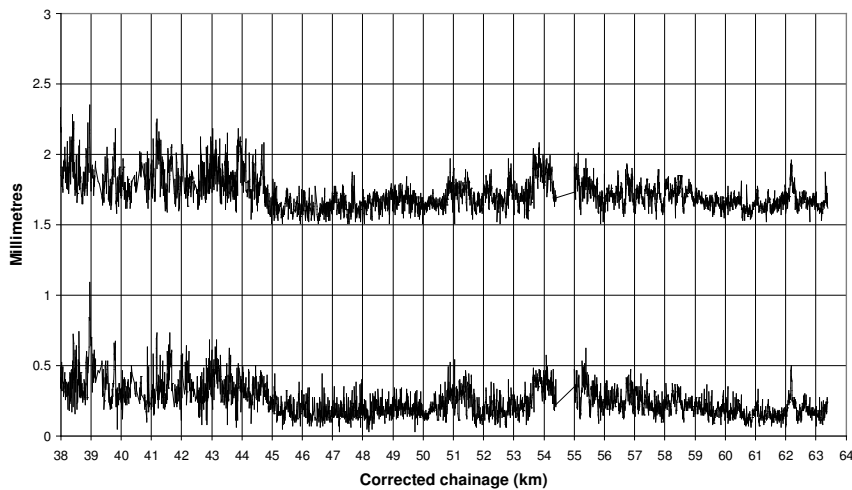

Rasesa - Monemetsana
Cusum for deflection data - complete surveyed length

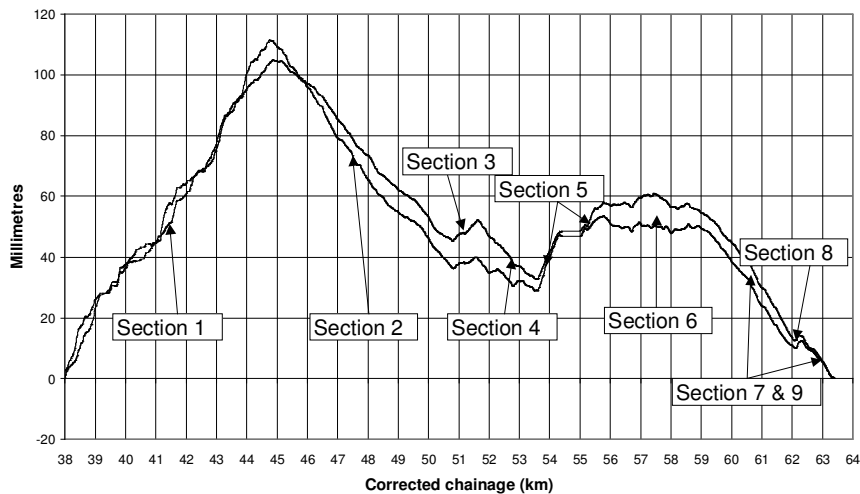

Figure H.2 Deflection data example.

Section number/chainage	Mean deflection and standard deviation (mm)			
	Initial delineation		Alternative processing	
	LHS	RHS	LHS	RHS
1: start to km 44,86	0,34 (0,13)	0,35 (0,12)	0,34 (0,13)	0,35 (0,12)
2: km 44,86 - km 50,79	0,16 (0,07)	0,19 (0,06)	0,17 (0,07)	0,20 (0,07)
3: km 50,79 - km 51,62	0,25 (0,07)	0,30 (0,08)	0,25 (0,07)	0,30 (0,08)
4: km 51,62 - km 53,59	0,16 (0,07)	0,19 (0,06)	0,17 (0,07)	0,20 (0,07)
5: km 53,59 - km 55,64	0,32 (0,09)	0,34 (0,09)	0,32 (0,09)	0,34 (0,09)
6: km 55,64 - km 59,04	0,22 (0,07)	0,24 (0,07)	0,17 (0,07)	0,20 (0,07)
7: km 59,04 - km 62,19	0,16 (0,05)	0,17 (0,05)	0,17 (0,07)	0,20 (0,07)
8: km 62,19 - km 62,44	0,21 (0,08)	0,20 (0,07)	0,21 (0,08)	0,20 (0,07)
9: km 62,44 - km 63,39	0,16 (0,05)	0,17 (0,05)	0,17 (0,07)	0,20 (0,07)
Comment	Data combined for sections 2 and 4, and for sections 7 and 9		Data combined for sections 2, 4, 6, 7 and 9	

Table H.1 Possible uniform sectioning for deflection data.

The processing requires identifying the actual point at which the uniform section ends by direct examination of the Cusum data sets. For example, the first section is marked by a Cusum peak of about 110 on one beam and about 104 on the other. Paging through the data will quickly find where these values peak to identify the chainage and, the row number. This will define the range extents for averages and standard deviations.

The most efficient method for processing is then firstly identifying all change points, in terms of chainage and spreadsheet data row number, and only then calculating means and standard deviations. The reason for this is that all the calculation functions can be kept together and simply edited for the appropriate data ranges, rather than placing these all through the spreadsheet adjacent to the relevant tabulated spreadsheet data.

Without going into great detail on the specific values, it will be seen that the RHS values are generally the higher and in fact represent the outer wheel path. The higher values will in any case be used to define the characteristic deflections. For the particular data in this example, which are actually very low deflections overall, either method of processing in Table H.1 is basically sound. For this example, however, the initial delineation will be used to define the uniform section characteristics shown in Table H.2

Section no.	Deflection (mm)		
	Mean	Standard deviation	Representative deflection (90th percentile)
1	0,35	0,12	0,50
2	0,19	0,06	0,27
3	0,30	0,08	0,40
4	0,19	0,06	0,27
5	0,34	0,09	0,46
6	0,24	0,07	0,33
7	0,17	0,05	0,23
8	0,21	0,08	0,31
9	0,17	0,05	0,23

Table H.2 Summary of deflection analysis.

The best way to review the selection is to show the characteristic uniform section data superimposed on the actual deflection values, which readily confirms the validity of the selection or indicates further processing is required. This is shown in Figure H.3, in this case showing only the outer wheel path deflections (RHS), and on a larger vertical scale.

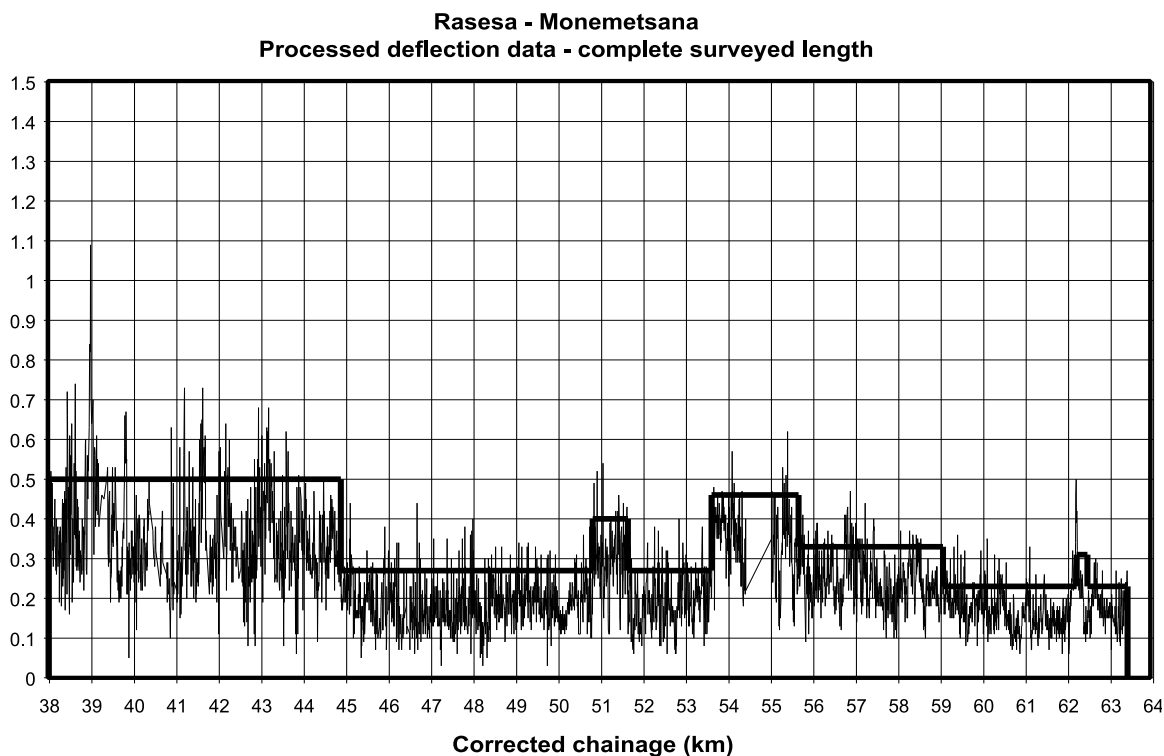

Figure H.3 Outer wheel path data and 90th percentile characteristic deflections.

D

Figure H.3 generally confirms the selection of uniform sections based on deflection data, but also shows that there are a series of significantly higher deflections near the start of section 1 (around km 38.4 to km 39 or so) that may need closer examination.

The result of the deflection survey will in any case be considered in conjunction with other data such as:

- (I) rut depths
- (II) layer thicknesses and layer strengths (typically determined with a DCP)
- (III) assessments of drainage conditions, and
- (IV) visual assessment of condition.

Thus the prevailing condition of the section can be fully evaluated.

Appendix I: Pavement condition rating form

Features			Culvert		Fort Jackson I/C		Eastbound C/W		Eastbound C/W							
	← King Williams Town		Westbound C/W		Westbound C/W		Westbound C/W		Westbound C/W							
Distance (km)	28	29	30	31	32	33	34	35	36	37	38	39	40			
Highway Section	N2/15															
Uniform Section	15 W1						15 W2									
Pavement Structure	Reseal															
	Surfacing	30 AS (1986)														
	Upper Base	100 ETB (1986) (Insitu Qtz 1%Bit, 1%Lime)						175 ETB (1986) (Insitu Qtz, 1%Bit, 1%Lime)			100 ETB (1986)					
	Lower Base	100 ETB (1986) (Insitu Qtz 1%Bit, 1%Lime)														
	Subbase	C3	150 G5 (1986)	150 G5 (1986)	150 C3 (1986) (Insitu Qtz/Shale, 3% OPC)	150 C3 (1986) (Insitu Shale /Dol, 3% OPC)	150 C3 (1986)	150 G2 (1972)	150 G5 (1972)	150 G5 (1972)	150 G5 (1972)	150 G5 (1972)	150 G5 (1972)			
Upper Selected	150 G5 (1972)															
Lower Selected	150 G5 (1972)															
CTO Traffic Data (AADT/Heavy%/Daily E80 per lane/Year of Count)	7351 / 35															
Cross Section	Fast shoulder															
	Fast lane															
	Slow lane															
	Slow Shoulder															
Instrument measurements	Distance (km)	28	29	30	31	32	33	34	35	36	37	38	39	40		
	Roughness (1998)															
	Rutting (1995, update 1997)															
	Deflection (1993)															
Visual assessments	Aggregate loss															
	Bleeding															
	Longitudinal/Transverse cracking															
	Crocodile cracking															
	Pumping															
	Failures/Patching															
	Deformation															
	Drainage															
Summary of Test Pit Results																
Distance (km)	28	29	30	31	32	33	34	35	36	37	38	39	40			
Legend :	Condition Ratings : <table style="display: inline-table; border: none;"> <tr> <td style="border: 1px solid black; padding: 2px;">Good</td> <td style="border: 1px solid black; padding: 2px;">Warning</td> <td style="border: 1px solid black; padding: 2px;">Severe</td> </tr> </table>													Good	Warning	Severe
Good	Warning	Severe														

Figure II Pavement condition rating form.

Appendix J: Definition of terms

Asphaltic concrete	A group of hot bituminous mixtures used for surfacing. They normally consist of a well graded mixture of coarse aggregate, fine aggregate and filler, bound together with penetration grade bitumen.
Base course	The layer(s) occurring immediately below the surfacing and above the subbase or, if there is no subbase, above the improved layers.
Behaviour	The function of the condition of the pavement with time (see also performance).
Bitumen emulsion	A binder in which bitumen has been dispersed in finely divided droplets in water by the aid of mechanical means and an emulsifying agent. Bitumen emulsion is made in an anionic and a cationic type depending on the particle charge of the bitumen in the material and the physical properties related to their behaviour during construction, (See also break).
Bitumen stabilized material	A material made of natural- or crushed aggregate with a bituminous binder admixed. Used in pavement layers – primarily for base course.
Bitumen rubber	A binder in which bitumen is modified with more than 15% ground rubber. (See also modified binder).
Bituminous seals	A general term for thin bituminous wearing courses made of surface treatments or slurry seals, or a combination of these.
Borrow pit	A borrow pit is a site from which natural material, other than solid stone, is removed for use in construction of the works. The term borrow area is also used.
Break of emulsions	'Break' of a bitumen emulsion is when the water and bitumen separates so that the water will evaporate, leaving behind the bitumen to perform its function.
Buses	All buses with a seating capacity of 40 or more.
Crushed stone	Crushed stones. Min 50% by mass of particles larger than 5 mm shall have at least one crushed face. Made from crushing of stones, boulders or oversize from natural gravel. Max 30% of the fraction passing the 4,75 mm sieve can be soil fines. The material is compacted to a specified relative density of BS-Heavy.
Curing membrane	A bituminous binder, usually made of bitumen emulsion, applied immediately after construction of a completed surface of modified or stabilized materials with lime or cement. Its purpose is to prevent early drying out of the cemented layer and to minimize adverse effects of the stabiliser's contact with CO ₂ in the air.
Cutback bitumen	A penetration bitumen which viscosity has been temporarily reduced by blending with solvents. The solvents are expected to evaporate during the early part of the pavement's service life. Classified according to their viscosity.
Cutting	A cutting is a section of the road where the formation level is below the original ground level.
Deflection	The recoverable vertical movements of the pavement surface caused by the application of a wheel load.
Deformation	A mode of distress, unevenness of the surface profiles.
Degree of distress	A measure of severity of the distress.
Distress	The visible manifestation of deterioration of the pavement with respect to either the serviceability of the structural capacity.
Dynamic Cone Penetrometer (DCP)	An instrument for assessing the in-situ CBR strength of granular materials/soils.
Earthworks	A general term describing all processed materials below formation level including improved subgrade layers, fill and prepared roadbed.
Embankment	An embankment is a section of the road where the formation level is above the original ground level.

Embankment, shallow	A shallow embankment is defined as a section of the road where the formation level is between 0 and 0.3 m above the original ground level.
Equivalent standard axle (E80)	Defined as an axle loaded to a weight of 8 160 kg, in the design concept meaning a unit of measuring the damaging effect to road pavements caused by axles of any load.
Fill	Material placed below the improved subgrade, but above the roadbed.
Fogspray	A light application of bitumen emulsion, sprayed on top of surface dressings. Its purpose is to improve retention of the aggregate in new seals. On old roads its purpose is to arrest any loss of chipping and to water-proof and rejuvenate the bituminous surfacing.
Formation level	The final level upon which the pavement layers are placed.
Geometric life	The life of a road before the functional capacity to carry additional traffic is exceeded.
Granular materials	Pavement materials made from crushed or natural sources, where no addition of any stabilizer has been made. (Term NOT to be used: Unbound materials).
Gravel wearing course	The uppermost layer of a gravel road, which provides the riding surface for vehicles.
Highway Design and Maintenance Standards Model (HDM)	HDM-3 and HDM 4 are computerized management systems for road networks developed by the World Bank.
Heavy goods vehicles (HGV)	All goods vehicles having 3 axles.
Heavy vehicles	A general term describing vehicles with un-laden weight of 3 tonnes or more. Heavy vehicles are further sub-grouped into Medium Goods-, Heavy Goods- Very Heavy Goods Vehicles and Buses for the purpose of determining design load in pavement design.
Improved subgrade	The uppermost layer(s) of the subgrade, consisting of material of controlled quality. (e.g. terms not be used: selected borrow – selected subgrade – capping layer – topping).
Life cycle cost	The cost of a pavement structure or surfacing discounted over its expected serviceable life.
Light vehicles	A general term describing vehicles with un-laden weight of less than 3 tonnes and includes buses with a seating capacity of less than 40.
Medium goods vehicles (MGV)	All goods vehicles having 2 axles and an un-laden weight of 3 tonnes or more.
MERLIN	Simple apparatus to measure road roughness.
Modified binder	A binder in which bitumen is modified with a prescribed percentage of polymers or other approved chemical constituents, alternatively with less than 15% ground rubber (See also bitumen-rubber).
Modified material	A material where the physical properties have been improved by the addition of a stabilizing agent but in which strong cementation has not occurred.
Natural gravel	Material from natural gravel sources. The term also includes crushed material where less than 40% of the mass of particles larger than 5 mm have a crushed face. Classified according to their minimum CBR strength. Used in pavement layers.
Natural gravel/soil	Material from natural sources. Classified according to their minimum CBR strength. Used in improved subgrade layers and fill.
Pavement behaviour	The function of pavement condition with time.
Pavement evaluation	The assessment of the degree to which the pavement fulfils its structural and functional requirements.
Pavement layers	The combination of material layers constructed above the formation level in order to provide an acceptable facility on which to operate vehicles.
Performance	The measure of satisfaction given by the pavement to the road user over a period of time, quantified by a serviceability/age function (see also behaviour).

D

Prime	An application of low viscosity bituminous binder to an absorbent surface, usually the top of the base course. Its main purpose is to protect the surface of a granular material during construction and to improve the bond between granular materials and bituminous mixes or seals.
Quarry	A quarry is an open surface working from which stone is removed for use in construction of the works.
Reflection cracks	Cracks in asphalt overlays or surface treatment that reflect the crack pattern of the pavement structure underneath.
Rehabilitation design period	The chosen minimum period for which a pavement rehabilitation is designed to carry the traffic in the prevailing environment, with a reasonable degree of confidence, without necessitating further pavement rehabilitation.
Roadbed	All in-situ ground after bush clearing, removal of topsoil and excavation of any cuttings, and before placing any layers, whether these layers are fill, improved subgrade or pavement layers.
Sand seal	A surface treatment made of sand aggregates of crushed or natural material. Can be constructed in single- or multiple layers.
Serviceability	The measure of satisfaction given by the pavement to the road user at a certain time, quantified by factors such as riding quality and rut depth.
Skid resistance	The general ability of a particular road surface to prevent skidding of vehicles.
Slurry seal	A cold premixed material of creamy consistency in a fresh state, made of crusher-dust, bitumen emulsion and cement filler. Water is added for adjustment of the consistency. If constructed in combination with a new surface dressing, it is named a Cape seal.
Structural capacity	The ability of pavement to withstand the effects of climate and traffic loading.
Structural design	The design of pavement layers for adequate structural strength under the design conditions of traffic loading, environment and subgrade support.
Structural distress	Distress pertaining to the load bearing capacity of the pavement.
Structural evaluation	The assessment of the structural capacity of pavement.
Subbase	The layer(s) occurring below the base course and above the improved subgrade layer.
Subgrade	The completed earthworks within the road prism before the construction of the pavement layers.
Surface dressing	A surface treatment made of single sized aggregates of crushed material. Can be constructed in single- or multiple layers.
Surface treatment	A general term for thin bituminous wearing courses made by lightly rolling aggregate into a sprayed thin film of bitumen. Aggregates can be made of crushed or natural material with a grading depending on the desired type of surface treatment to be produced. Can be constructed in single or multiple layers.
Surfacing integrity	A measure of the condition of the surfacing as an intact and durable matrix (it includes values of porosity and texture).
Surfacing bituminous	The uppermost pavement layer(s), which provides the riding surface for vehicles. Includes bituminous wearing course and bituminous binder course where used.
Tack coat	An application of bituminous binder to a bituminous surface subsequent to placing a bituminous layer. Usually made of bitumen emulsion with the purpose to improve the bond between bituminous layers.
Terminal level	A minimum acceptable level of some feature of the road in terms of its serviceability.
Types of distress	The sub-classification of the various manifestations of a particular mode of distress.
Vehicle equivalency factor	The total number of equivalent standard axles calculated for one vehicle. The average of all these values within one vehicle category is subsequently calculated for ease of reference to traffic count data.
Very heavy goods vehicle (VHGV)	All goods vehicles having 4 axles or more.